

4

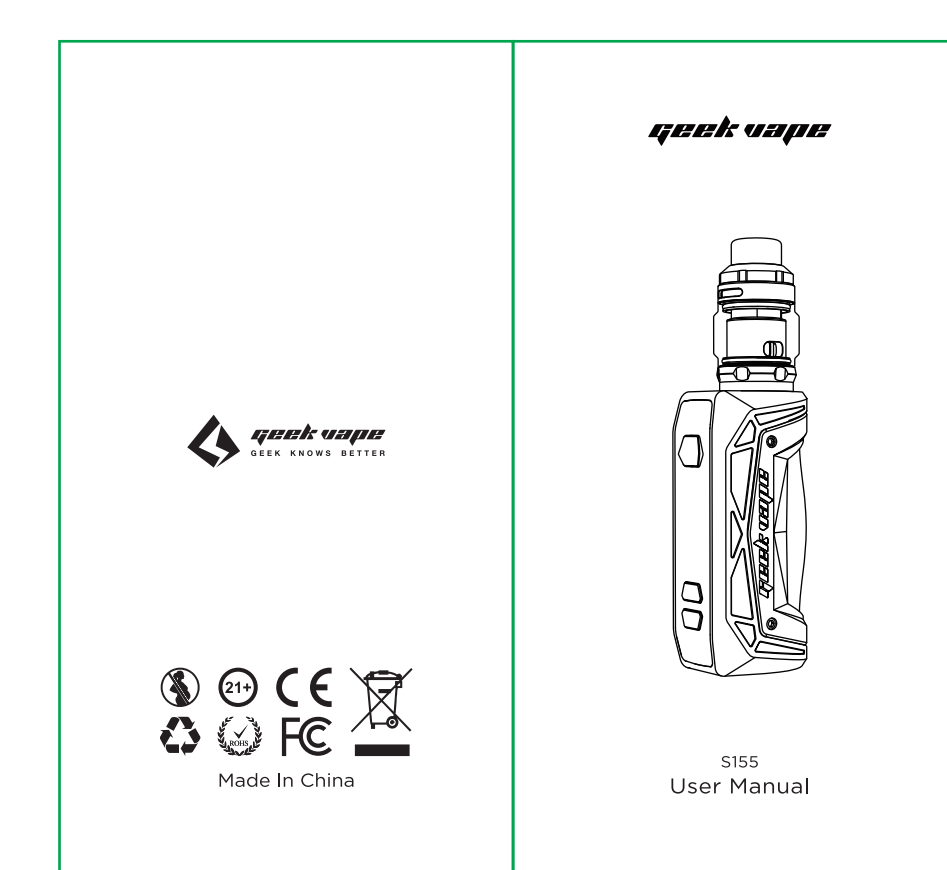

封底

封面

封二

封三

英语

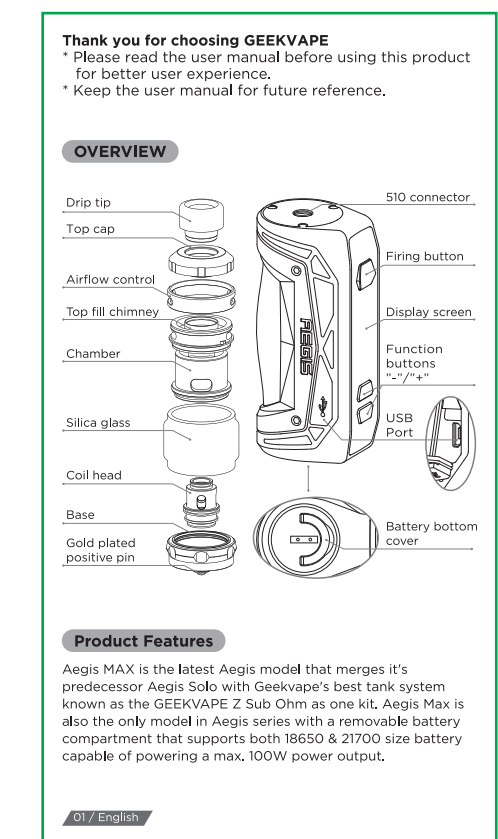

01

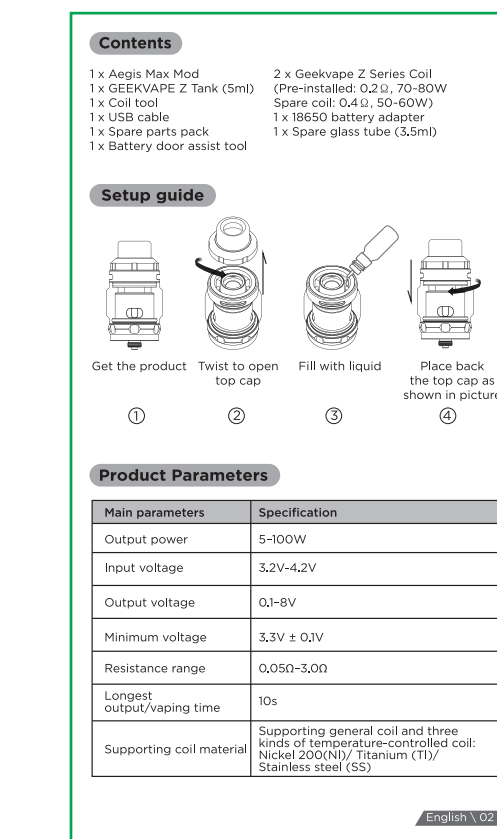

02

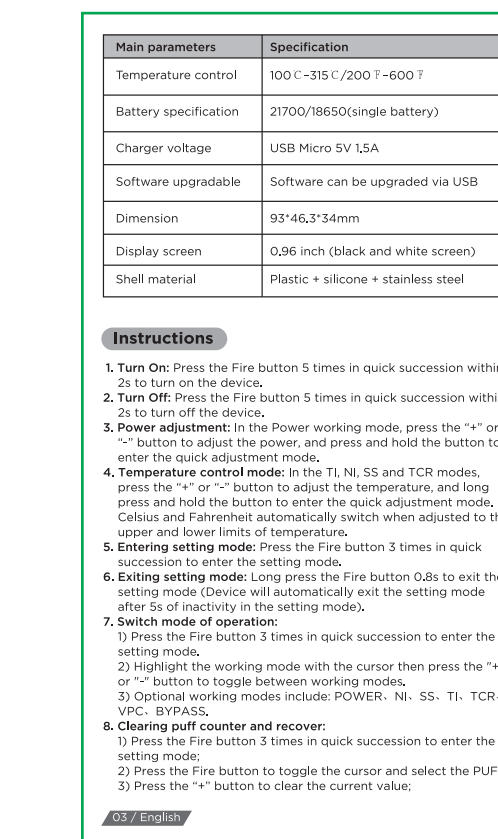

03

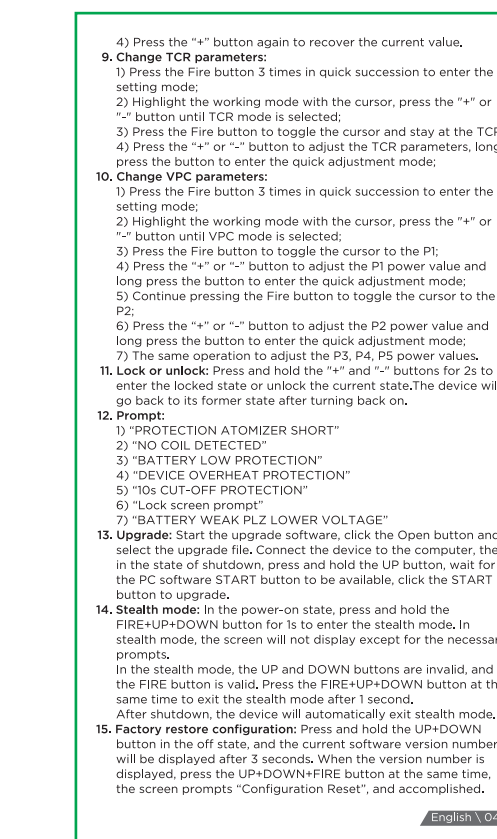

04

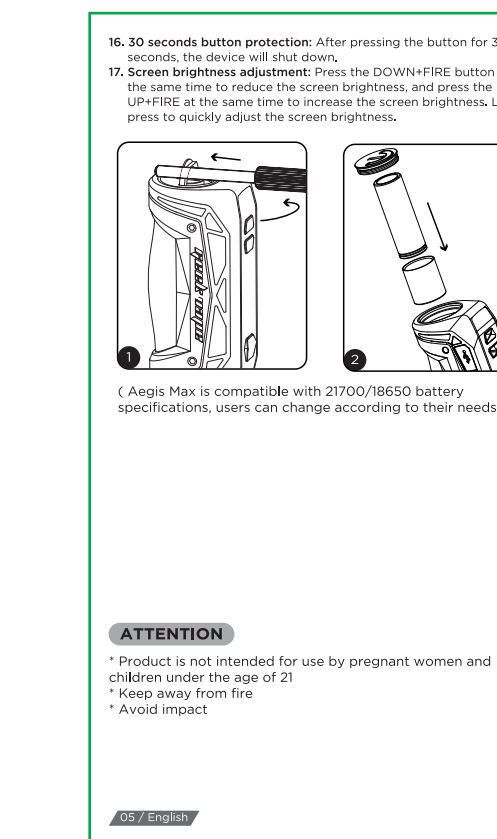

05

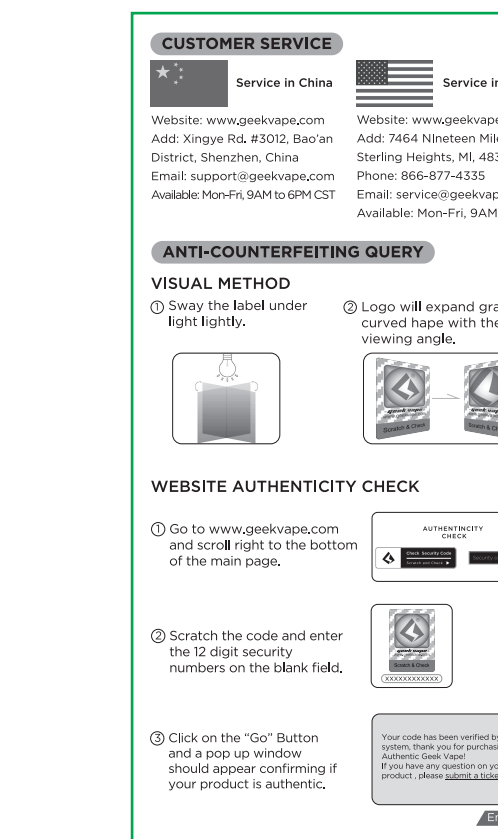

06

意大利

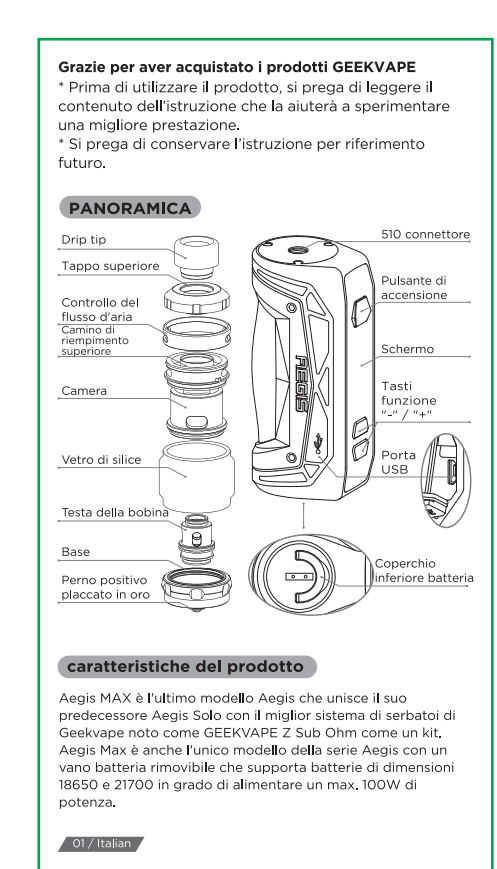

25

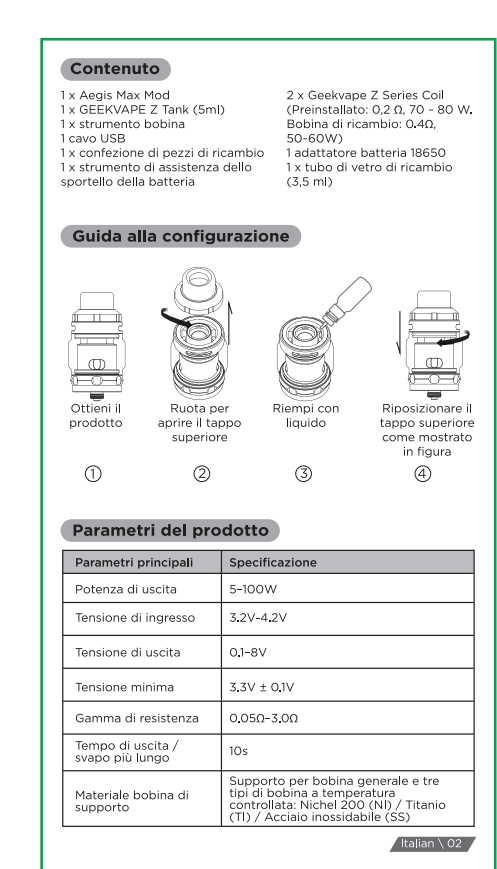

26

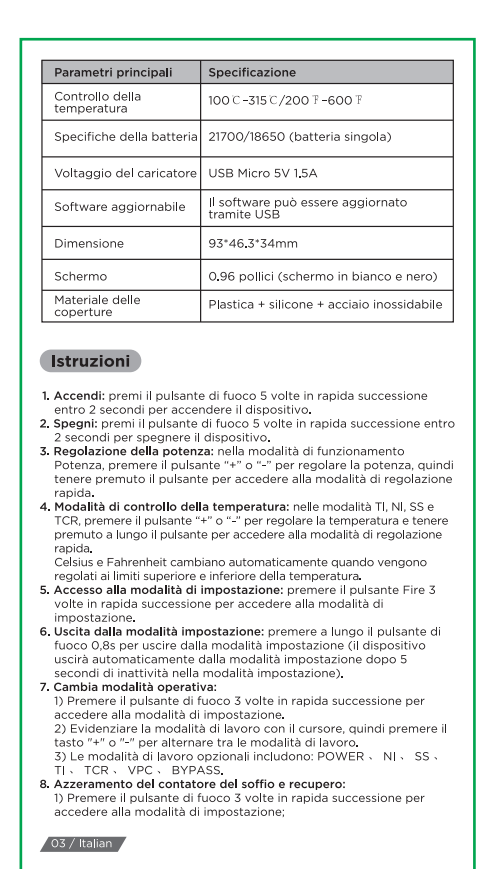

27

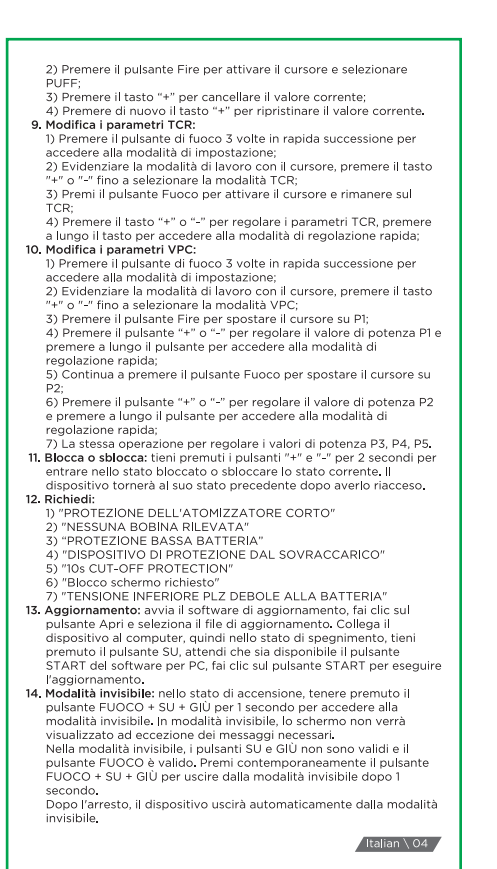

28

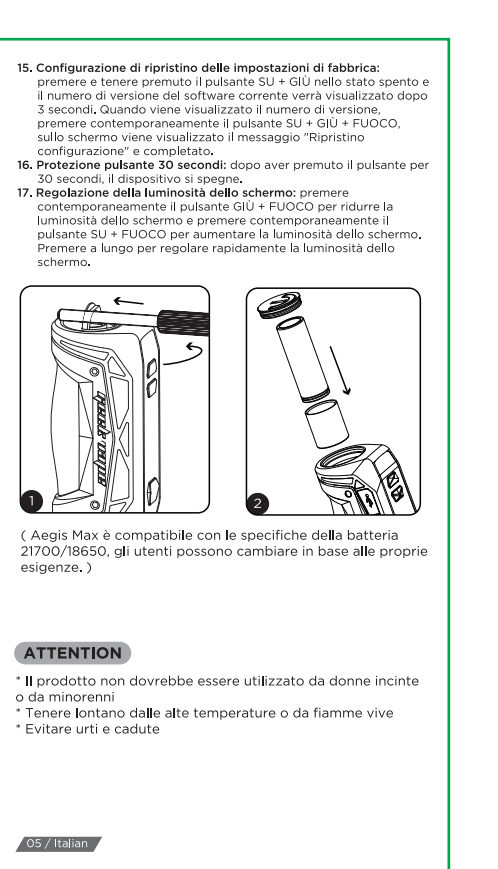

29



30

3

法语



07

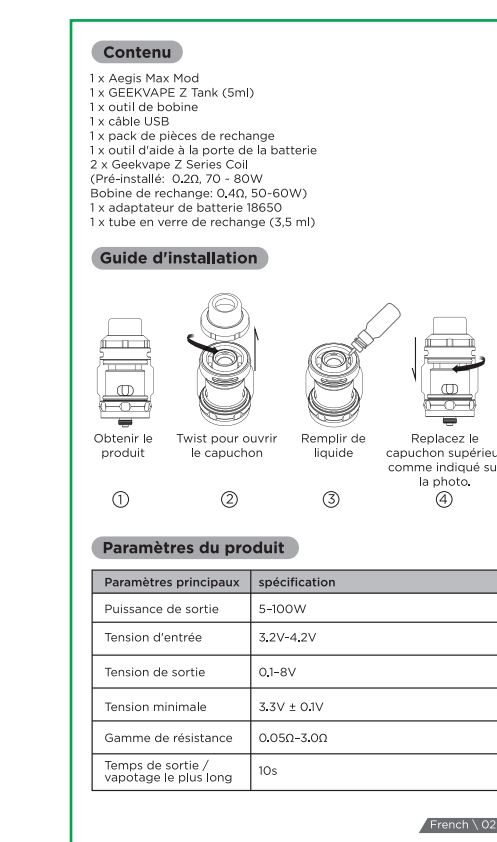

08

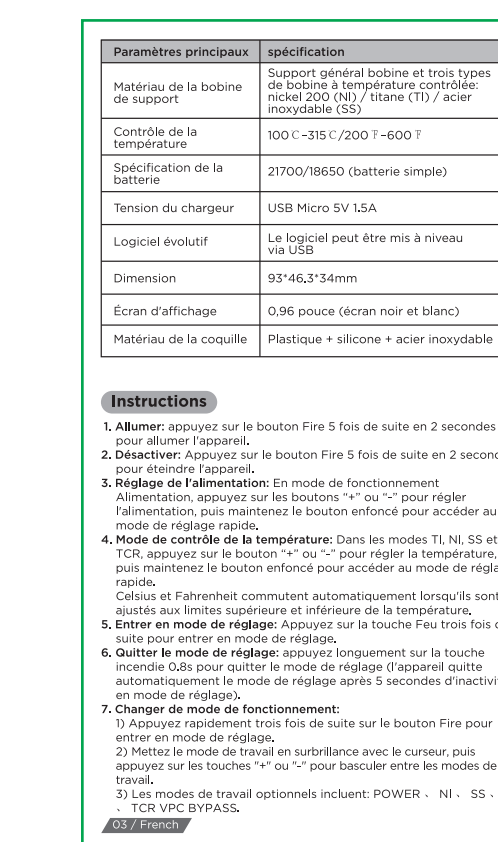

09

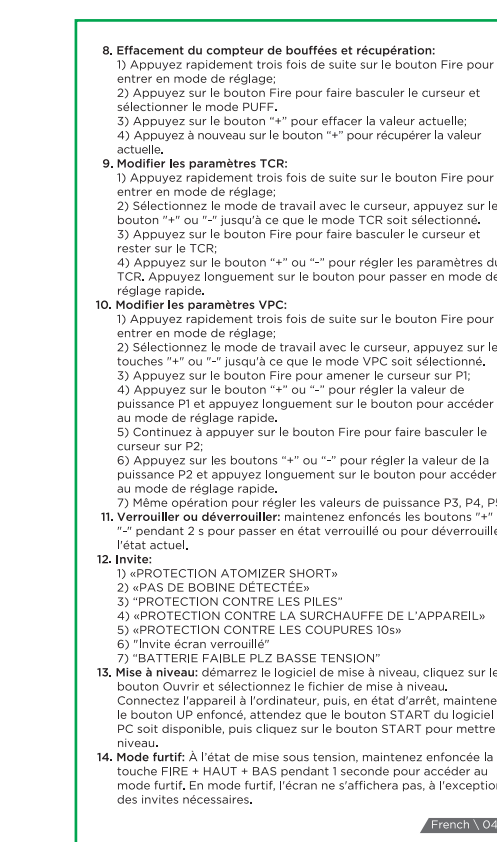

10

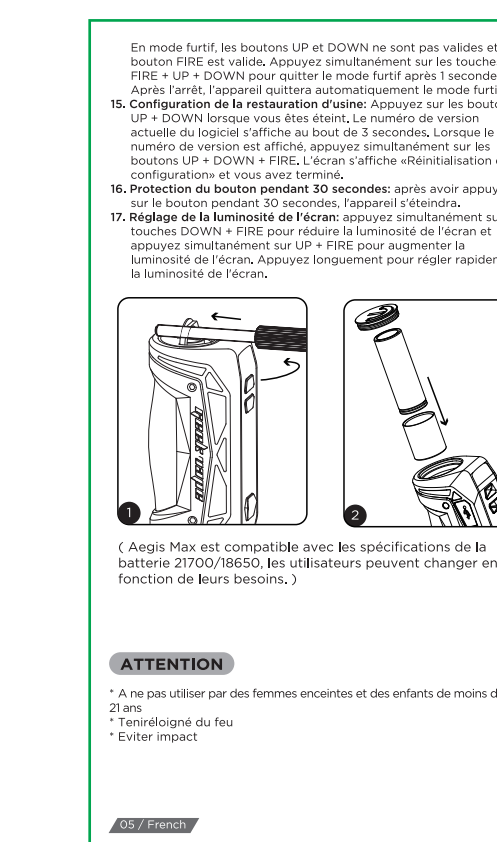

11



12

俄罗斯



31

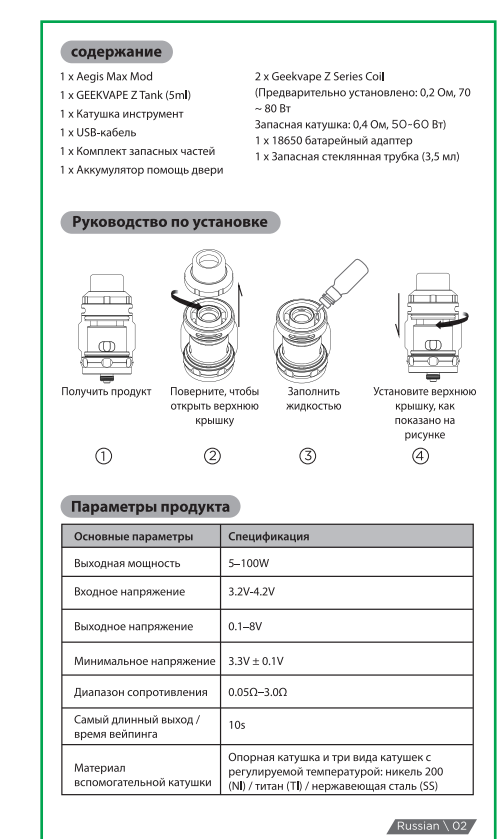

32

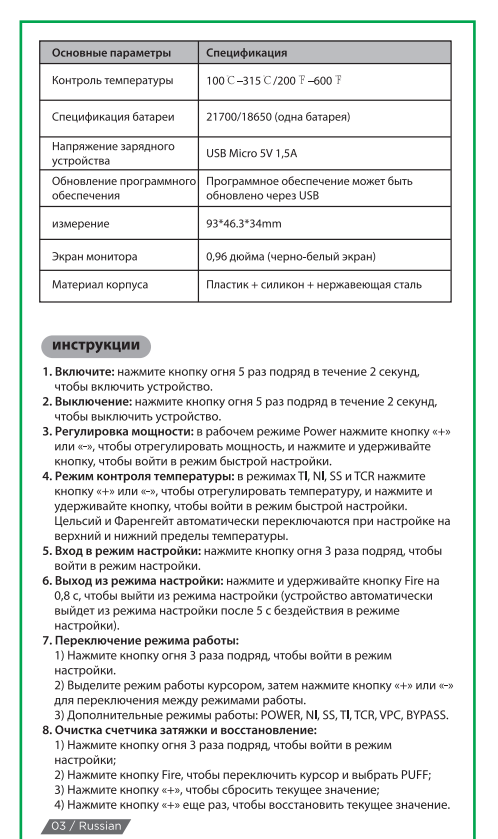

33

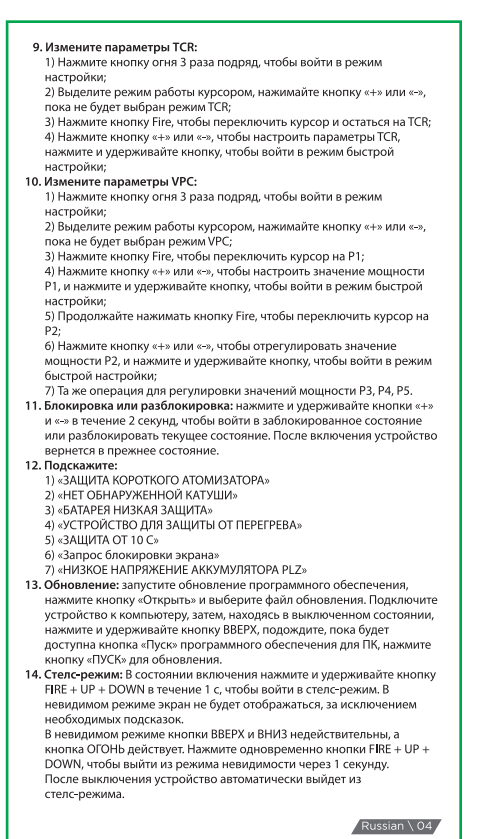

34



35

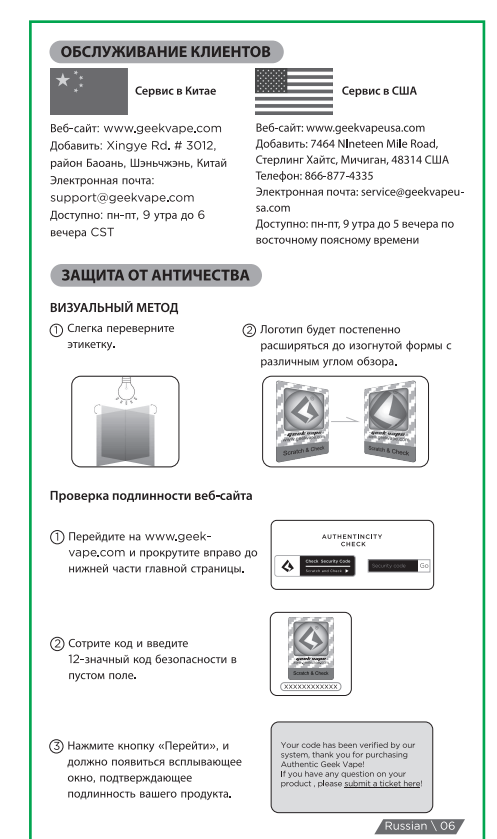

36

2

德语

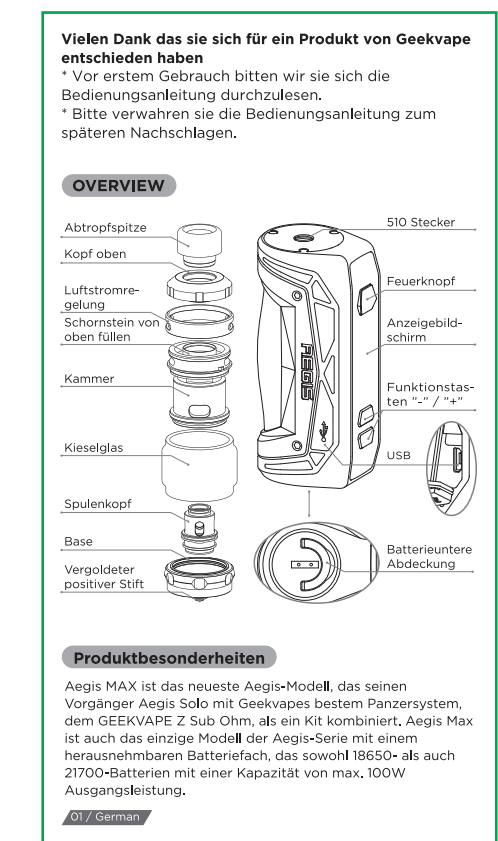

13

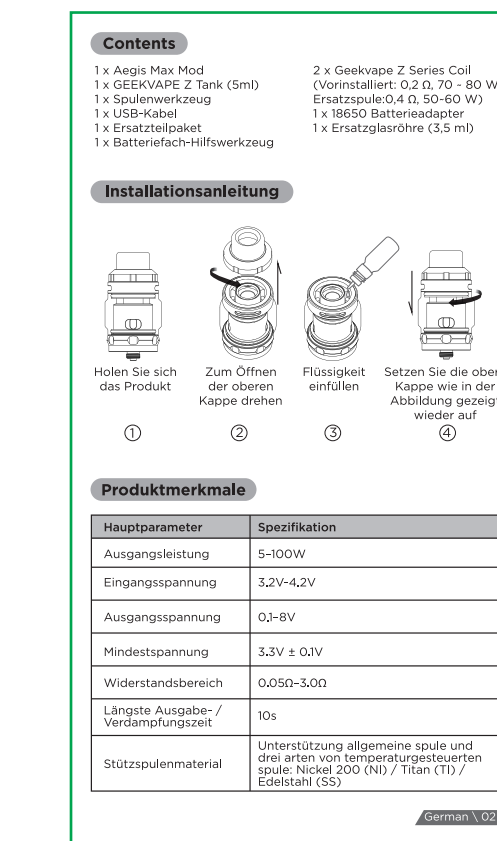

14

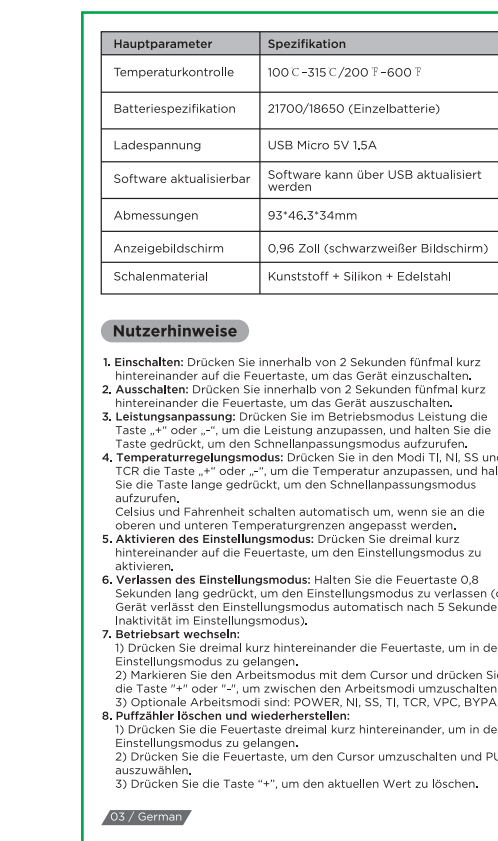

15

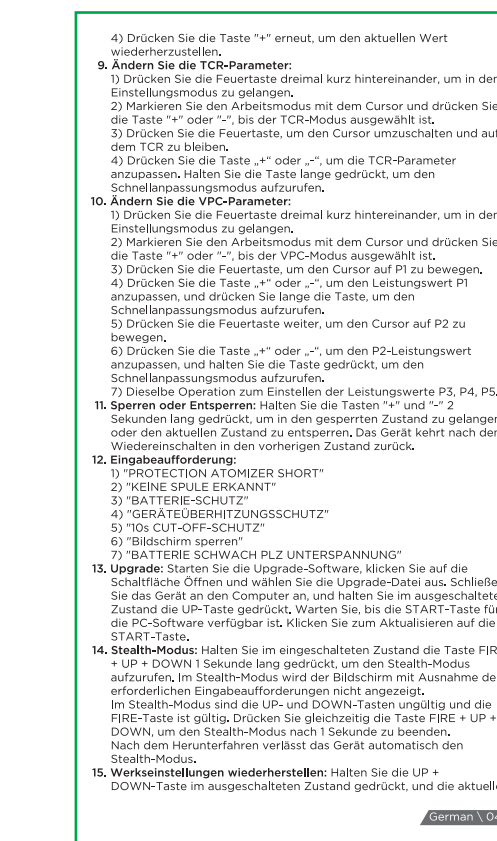

16

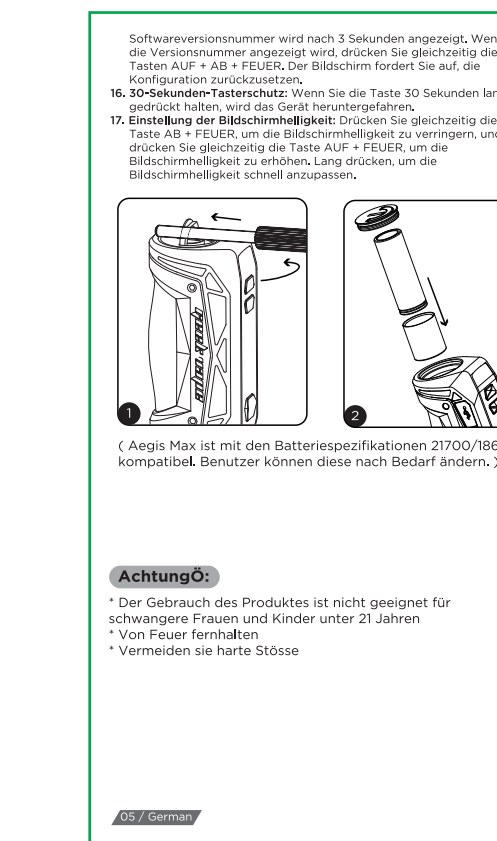

17



18

荷兰语

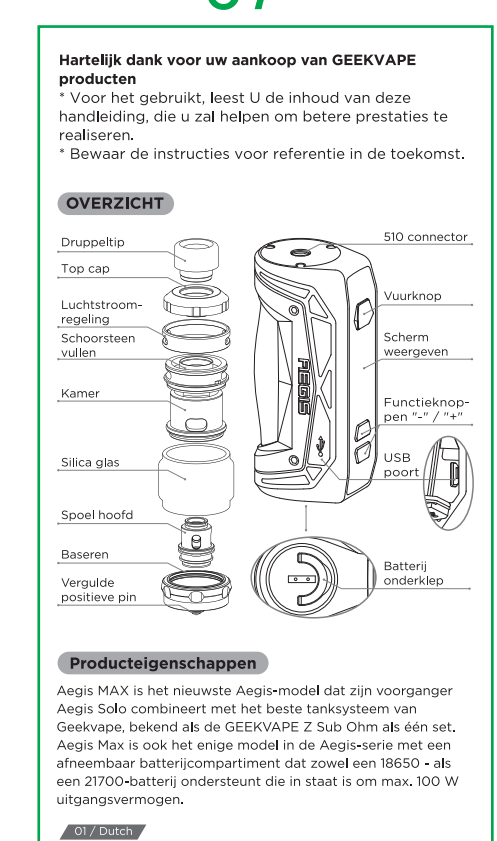

37

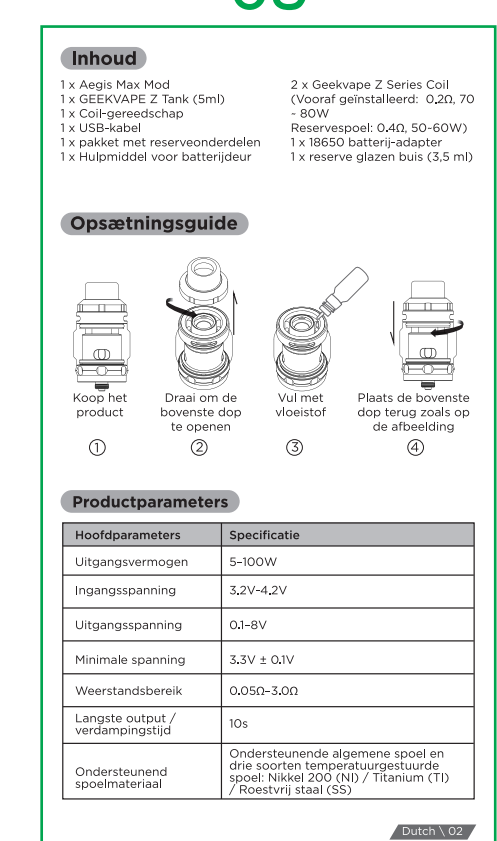

38

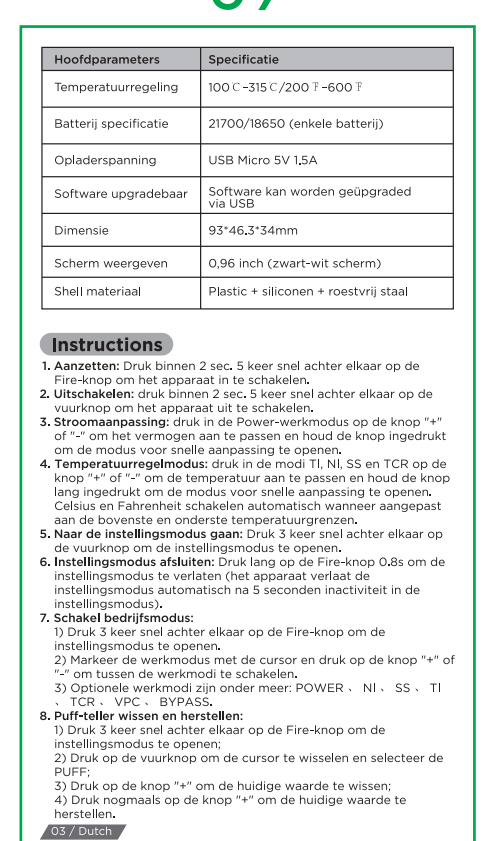

39

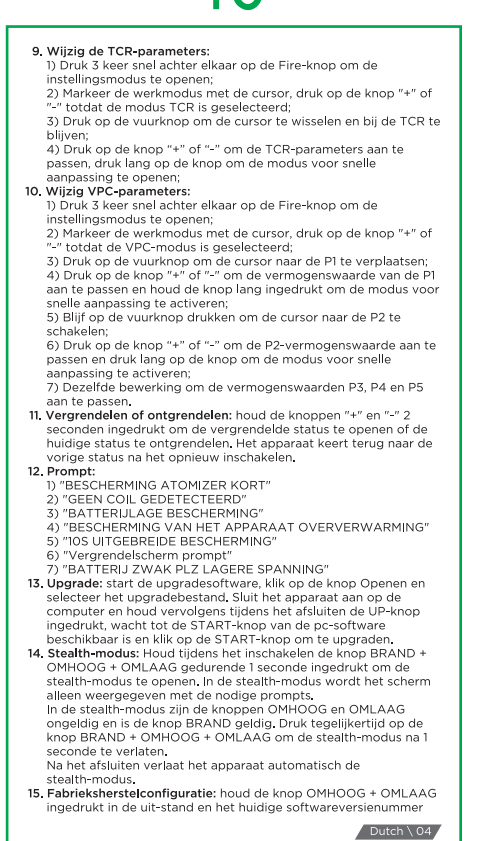

40

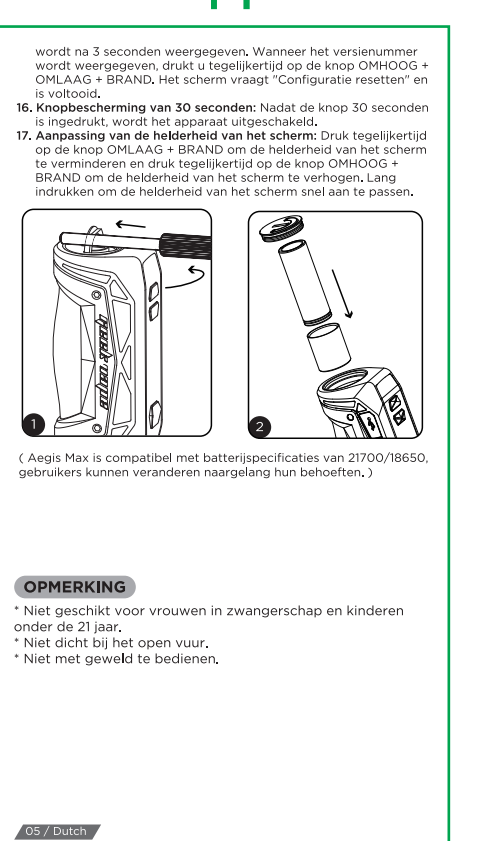

41

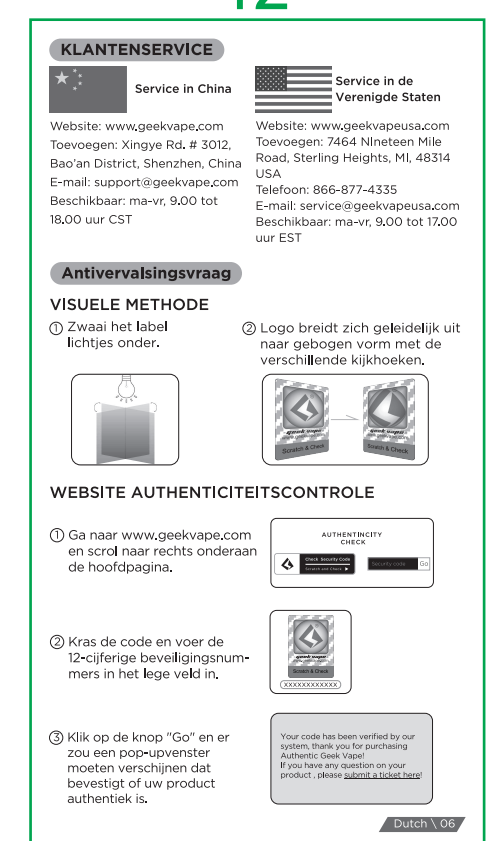

42

西班牙语



19

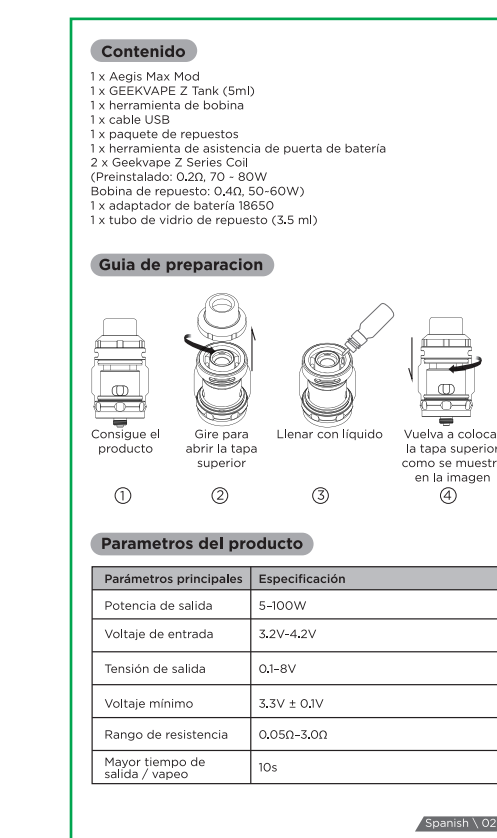

20

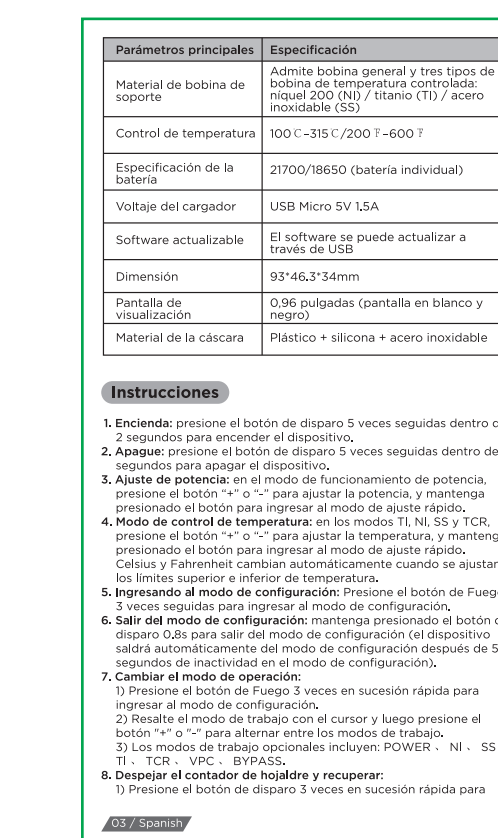

21

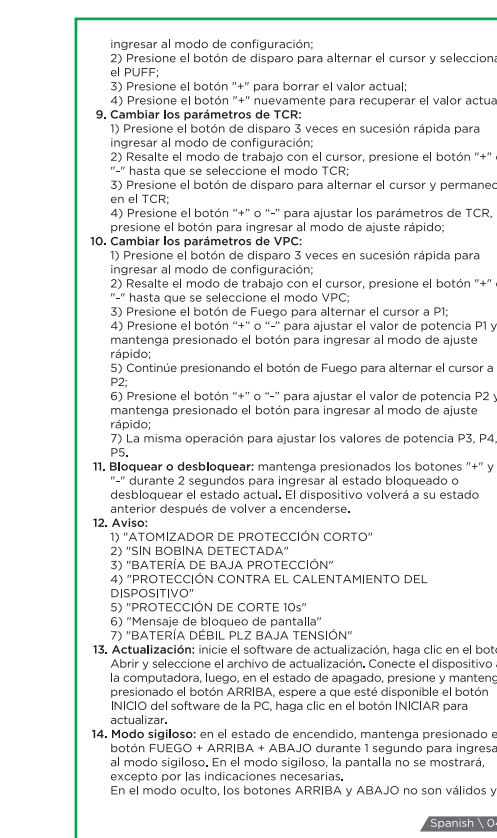

22

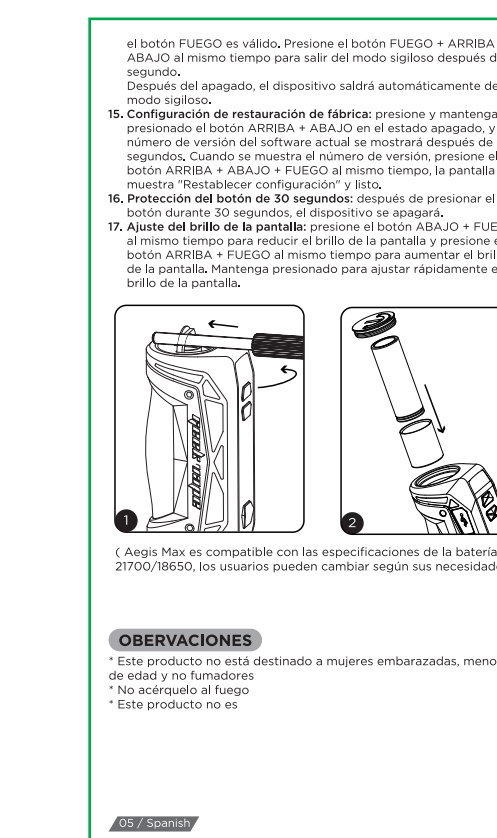

23



24

印尼语

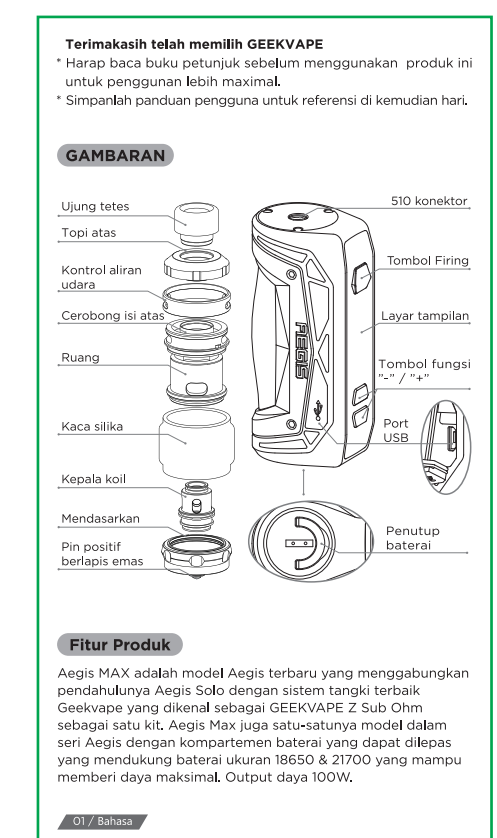

49

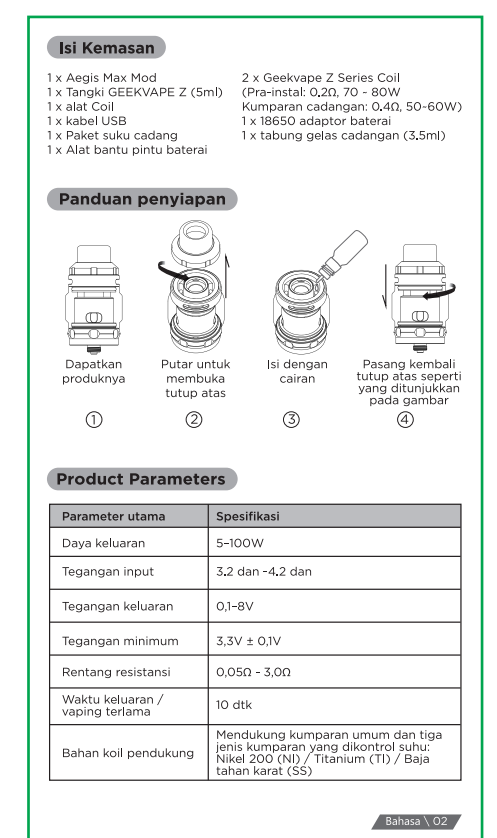

50

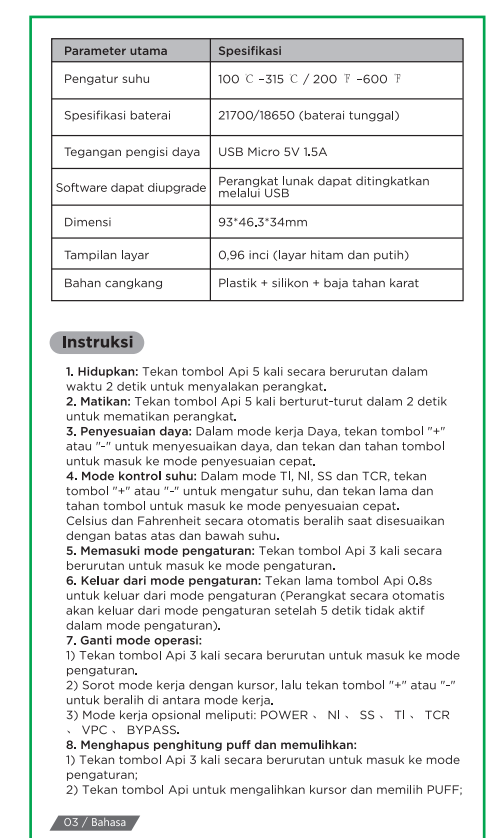

51

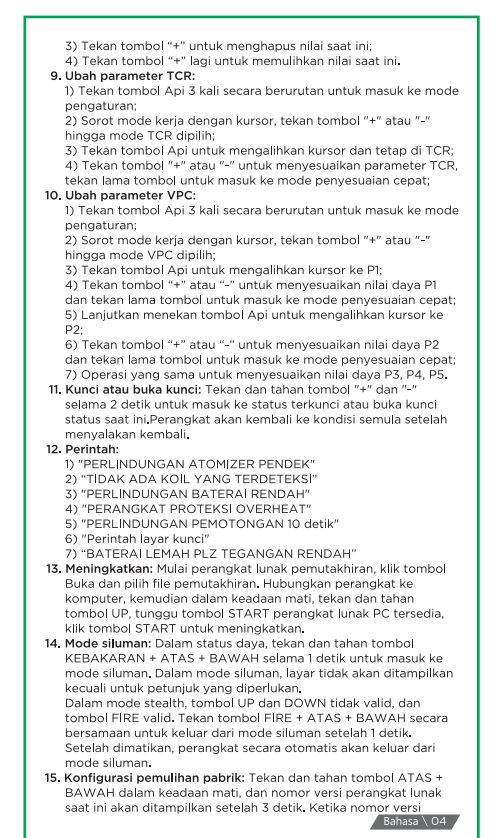

52

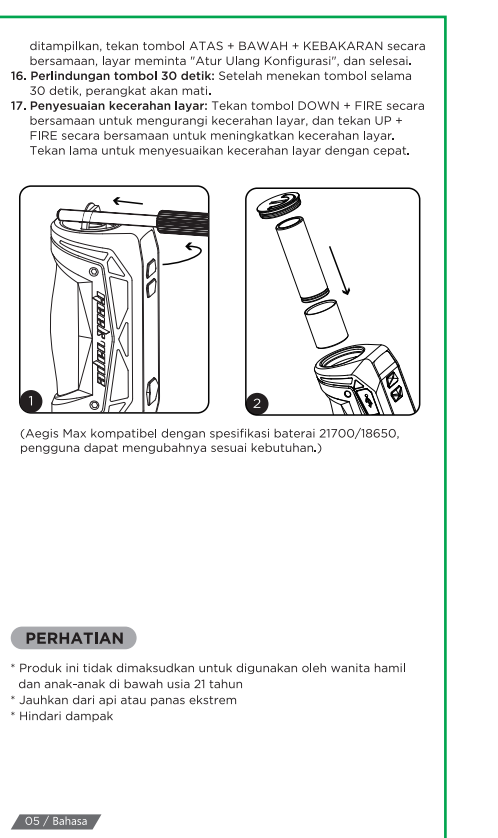

53



54

- 要求:
1. 材料: 80g 书纸
 2. 成品尺寸: 60*110mm ≤ 0.5
 3. 工艺: 双面印刷, 骑马订装订。
 4. 颜色: K, 色差 ΔE ≤ 1.00;
 5. 油墨, 要符合欧盟为 RoHS 环保标准。
 6. 页码顺序依次按封面、1...54、封四, 印刷以文件为准, 严格按图纸做货。裁切边缘须整齐无毛边。

注内容改动:
GEEKZEUS 改为 GEEKVAPE Z

深圳市基克纳科技有限公司 Geekvakpe Technology co, LTD		绘图 PRODUCTNAME	容蛟顺 2020/11/02	比例 SCALE 1:1
		审核 CHECKED		UNIT(单位) : mm REV(版本) : A2
未标公差 OTHER TOLERANEC	产品名称 PRODUCTNAME	Aegis Max Kit - 说明书		
	产品编码 PART NO	S-155		
	产品图号 PART NO	S-155-P-06		
	核准 APPROVED			

