

4

3

2

1

A

B

C

D

E

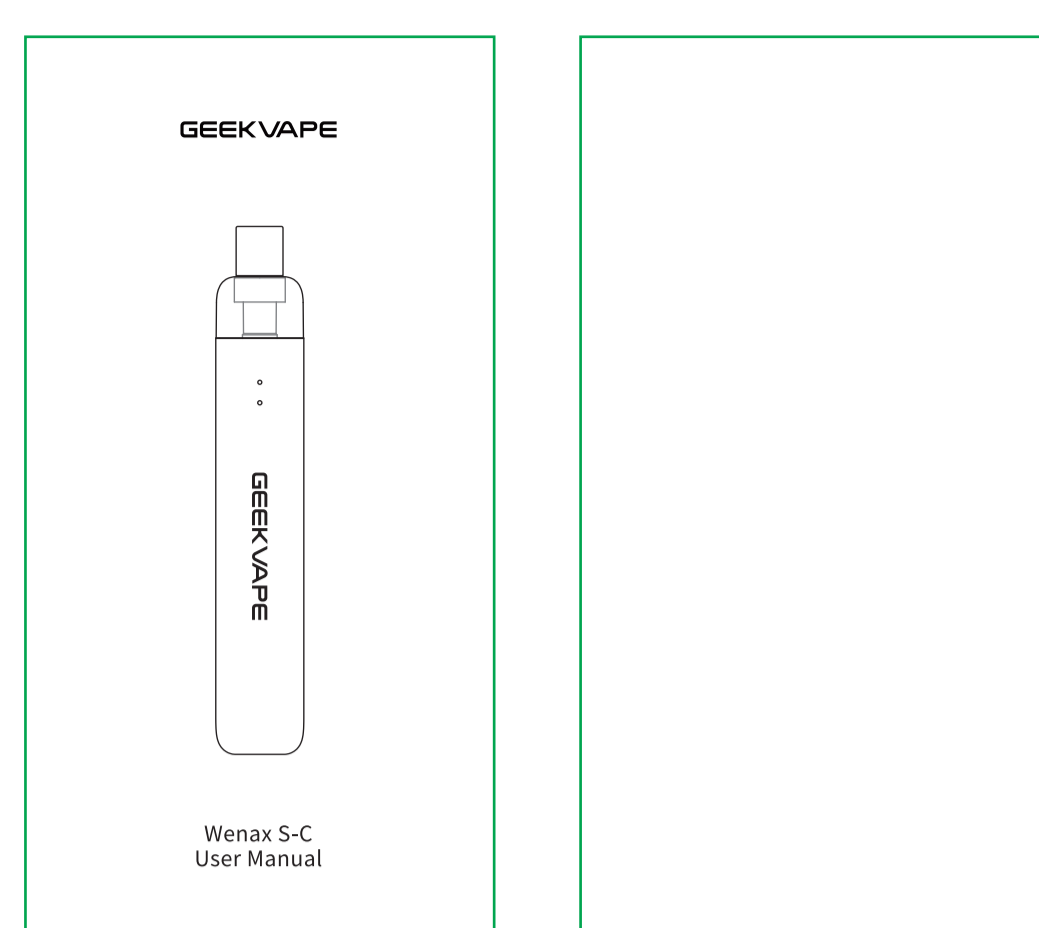

封面

封二

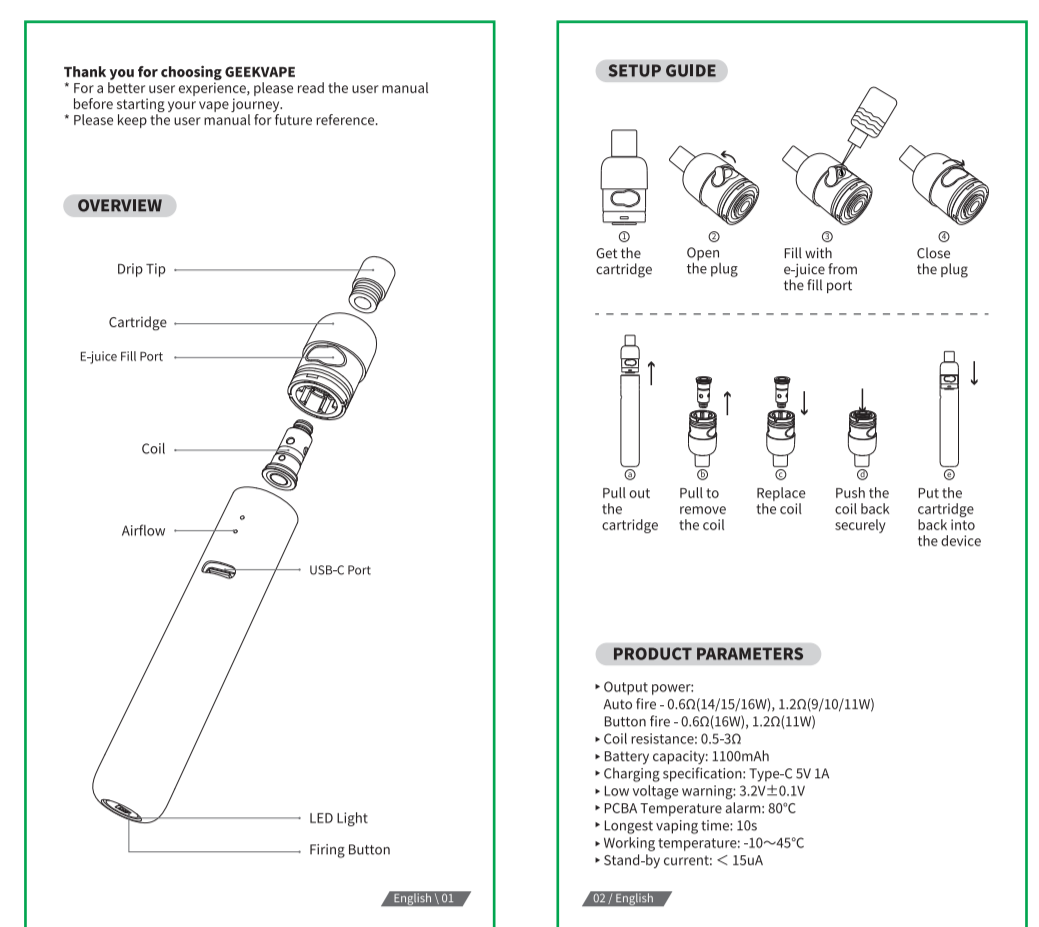

1

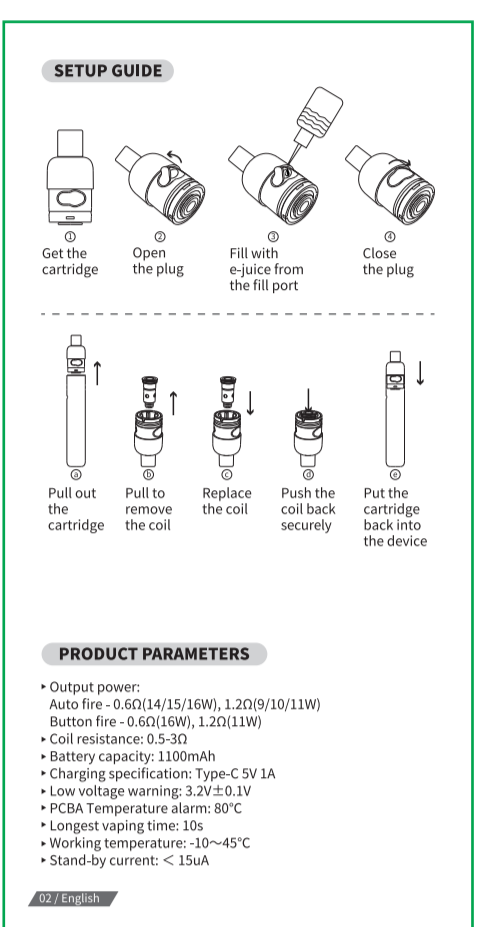

2

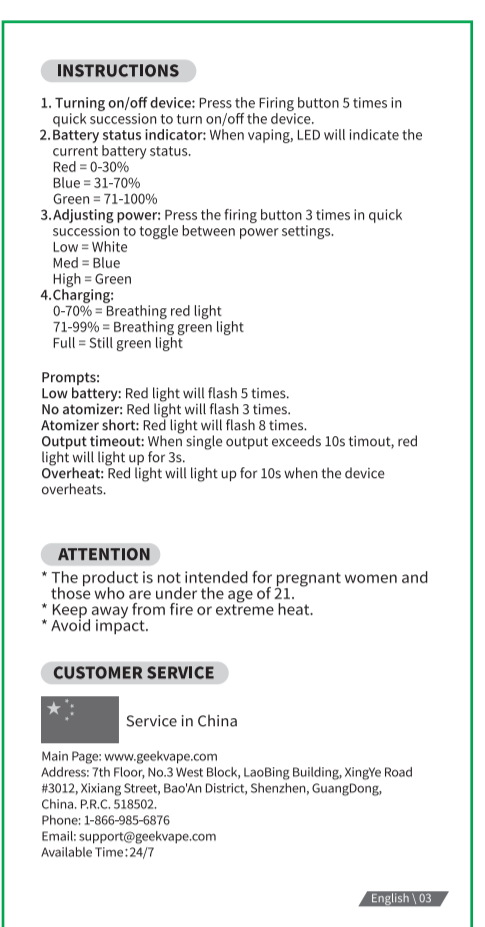

3

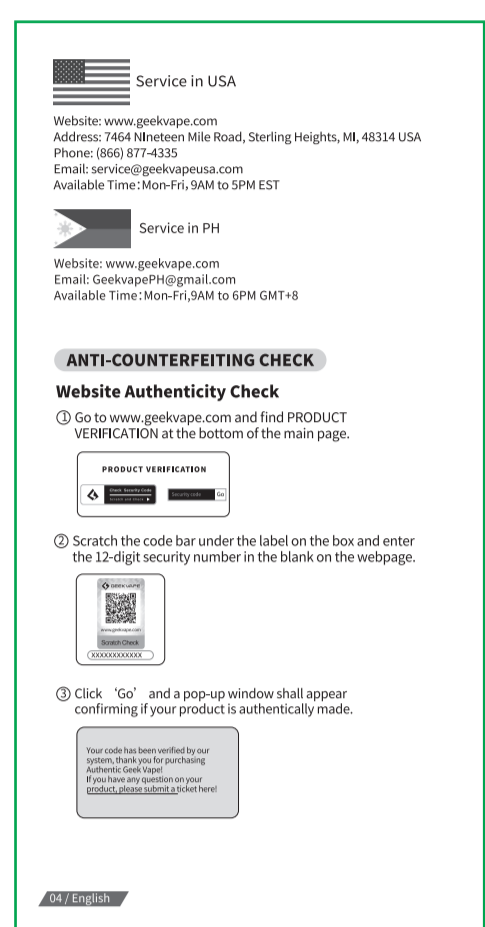

4

英语

法语

德语

西班牙语

意大利语

俄语

丹麦语

荷兰语

印尼语

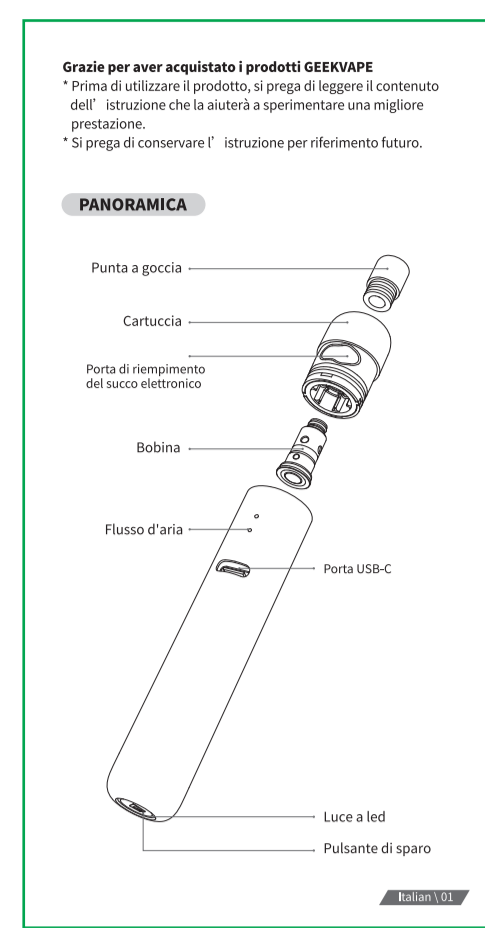

17

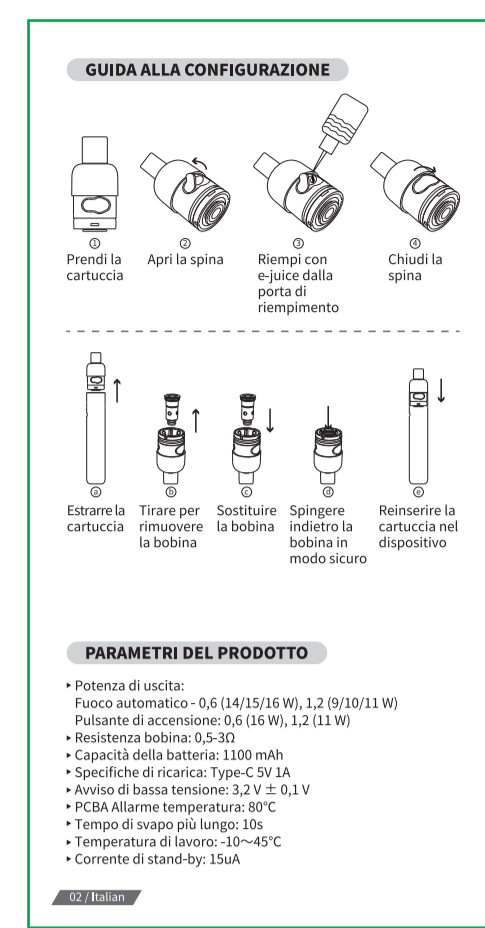

18



19

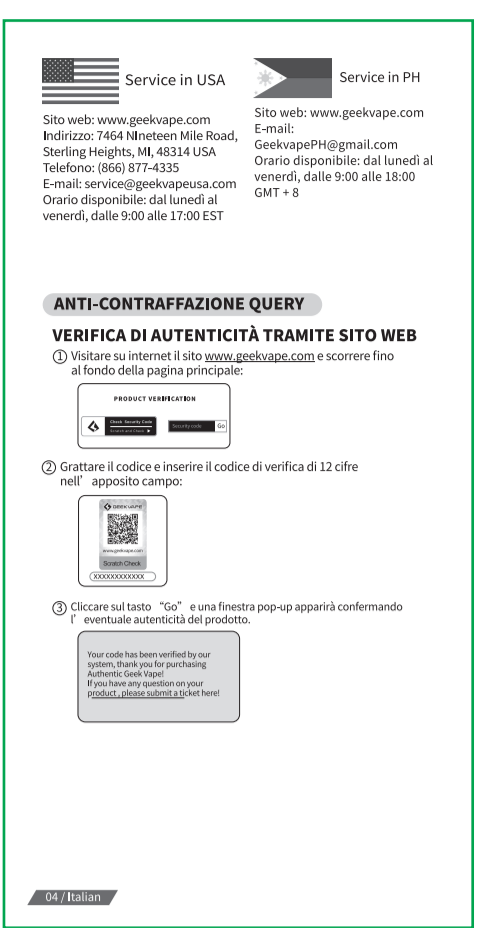

20

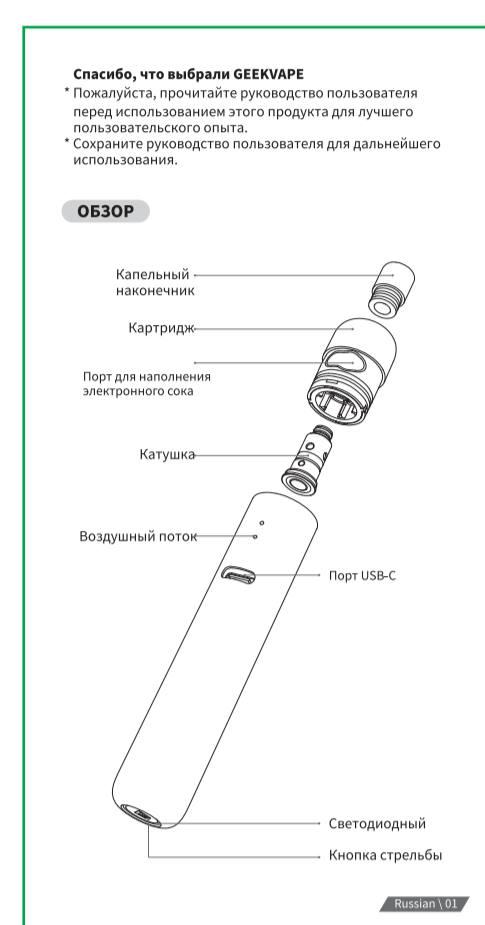

21



22

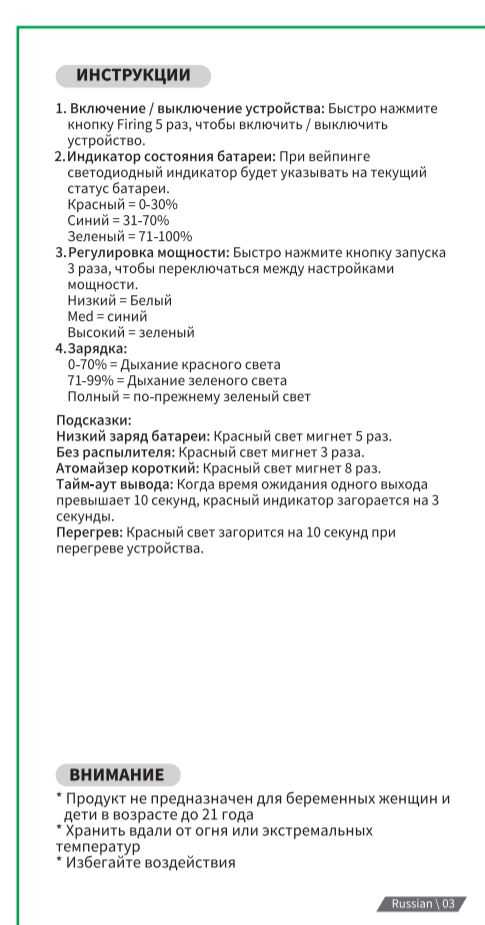

23



24

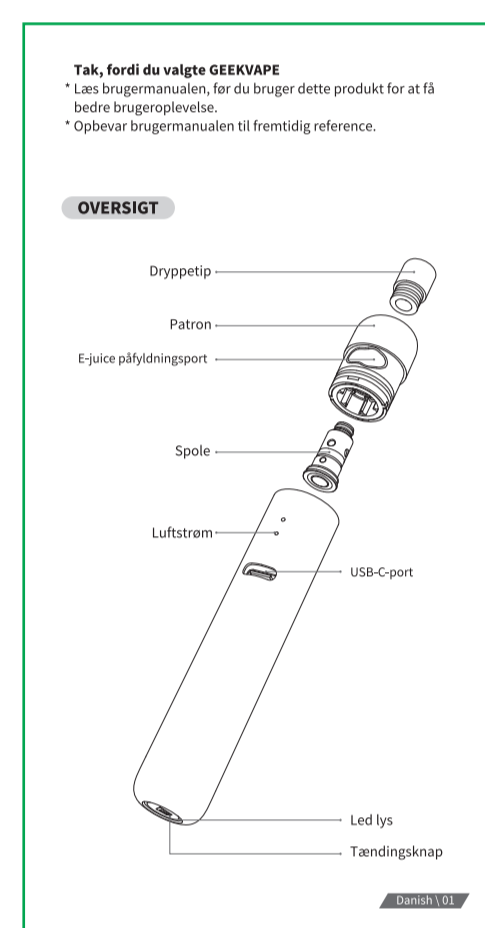

25

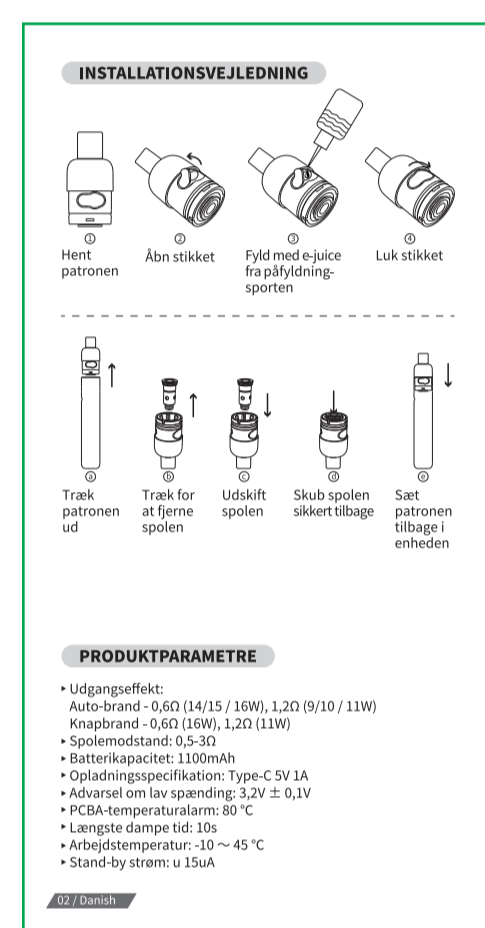

26

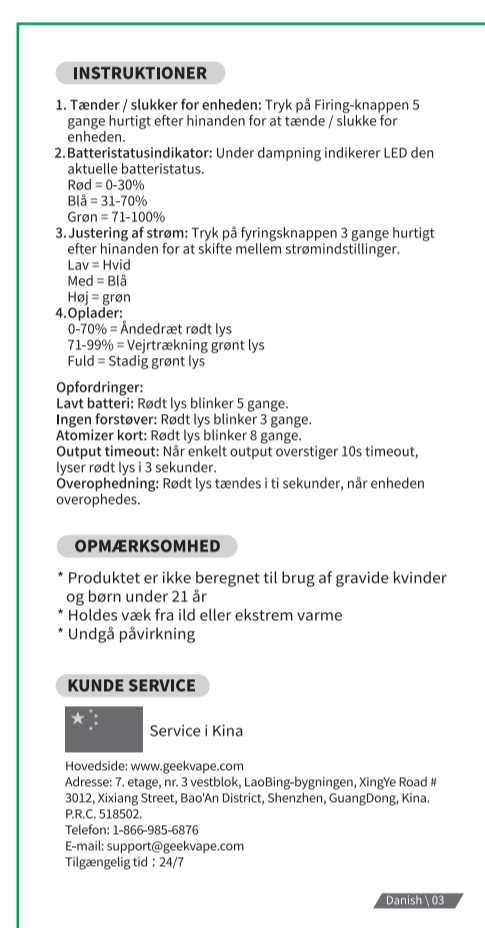

27

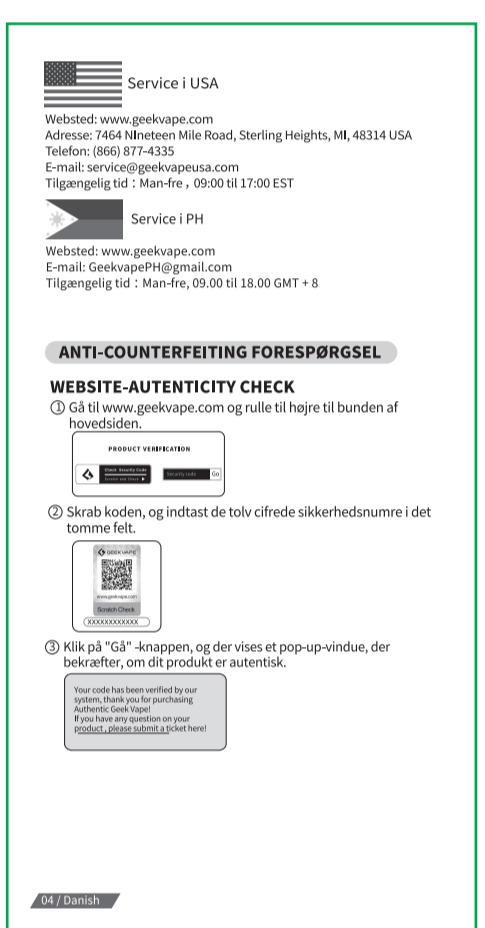

28

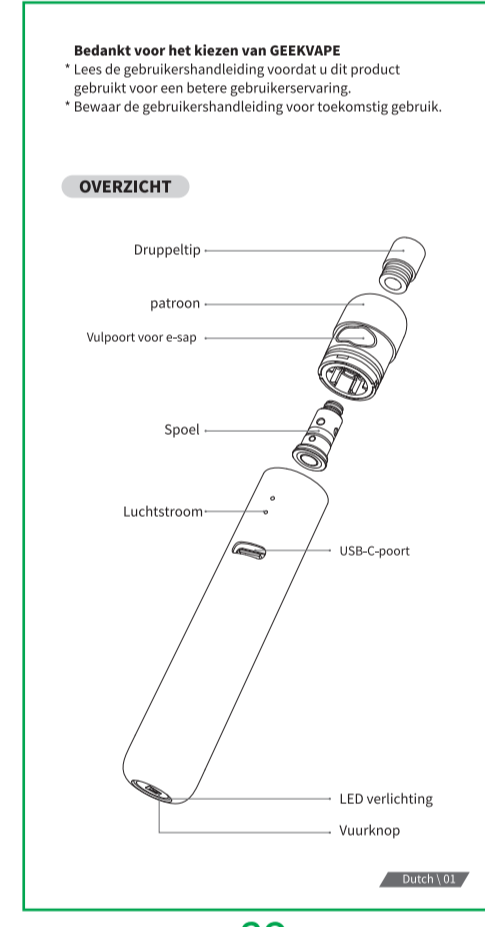

29

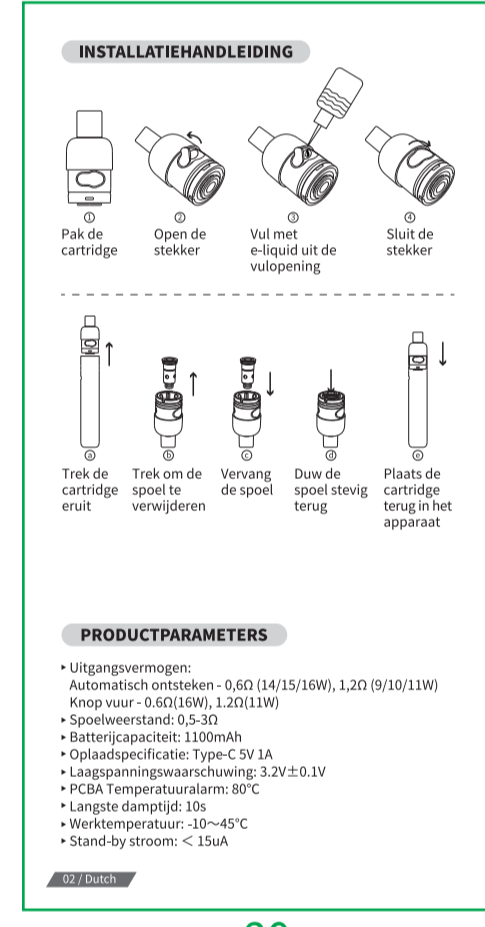

30

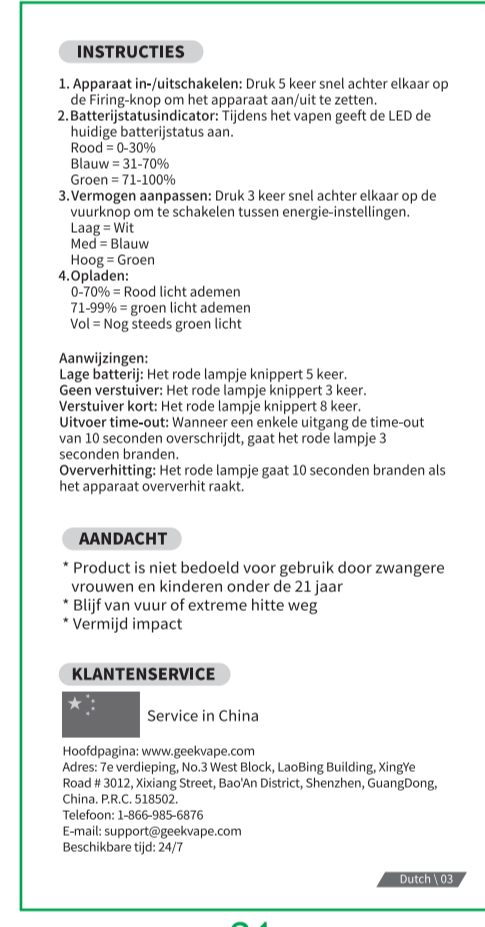

31



32

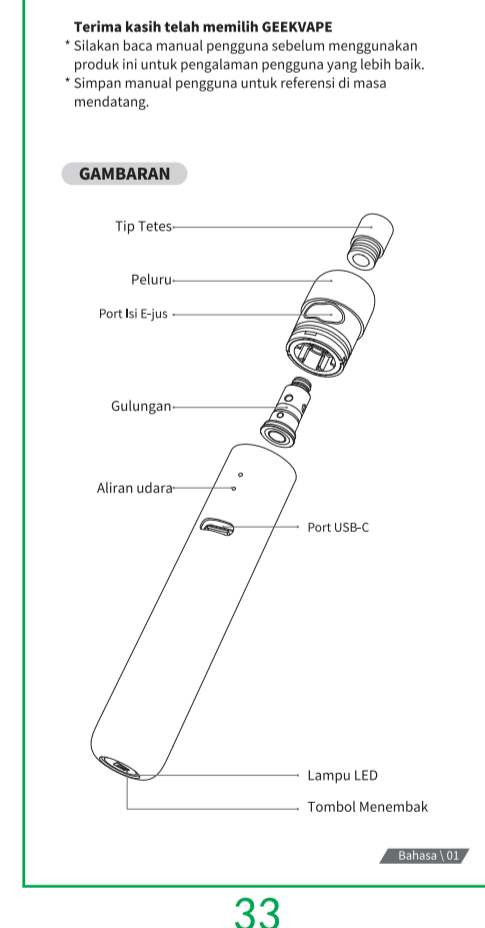

33

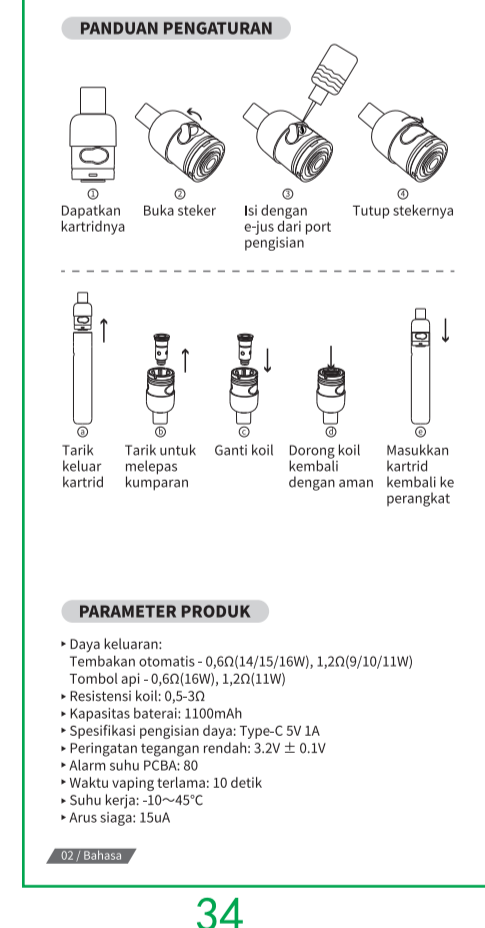

34

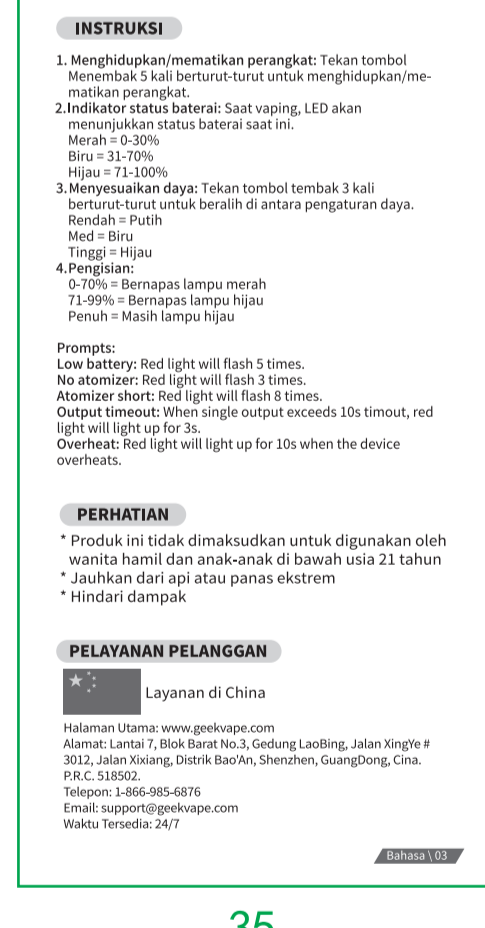

35

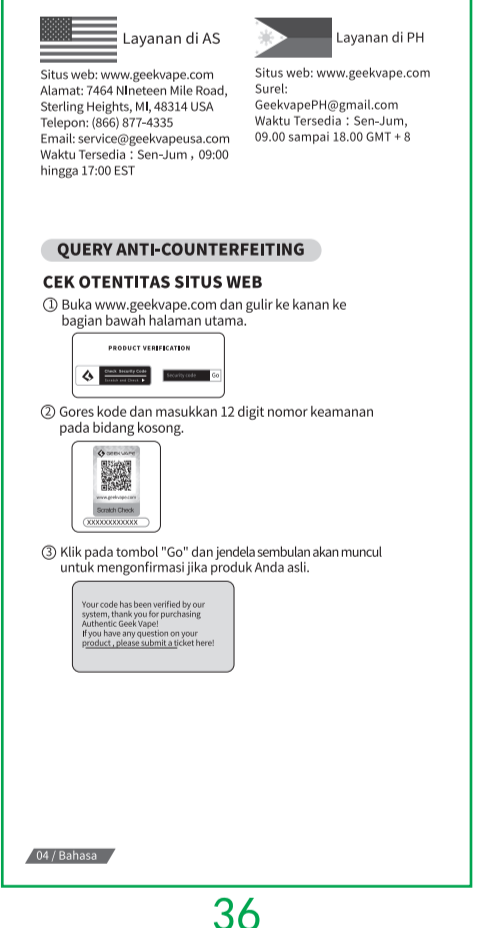

36

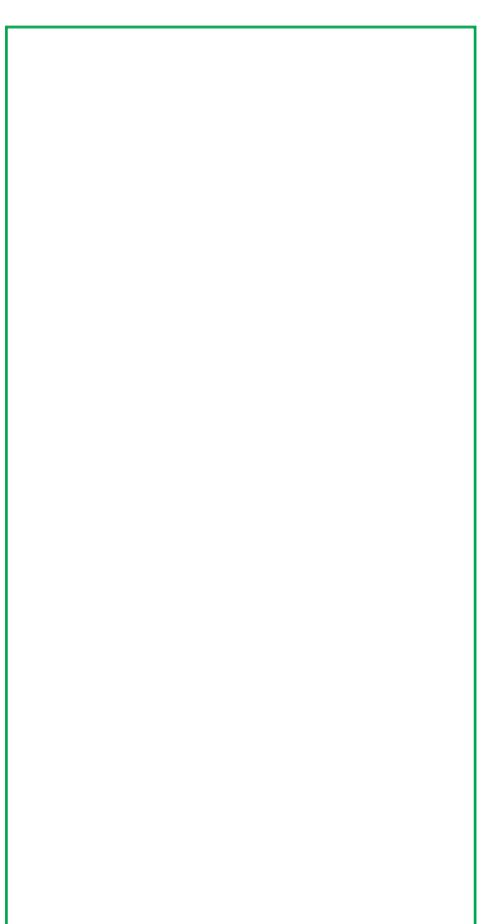

封三



封底

- 要求:
- 1.材料: 80g书写纸
  - 2.成品尺寸: 62\*120mm ≤ 0.5
  - 3.工艺: 双面印刷, 骑马订, 40P。
  - 4.颜色: 印单黑, 色差ΔE ≤ 1.00
  - 5.油墨, 要符合欧盟为RoHS环保标准。
  - 6.页码顺序依次按封面、封二、1、2...35、36、封三、封底印刷以文件为准, 严格按图纸做货。裁切边缘须整齐无毛边。

 深圳市基克纳科技有限公司 Geekvape Technology co, LTD			绘图 PRODUCTNAME	魏鹏	比例 SCALE 1:1
			审核 CHECKED	2021/08/05	UNIT(单位) : mm
未标公差 OTHER TOLERANEC	产品名称 PRODUCTNAME	Wenax S-C - 说明书	核准 APPROVED		REV(版本) : A1
	产品编码 PART NO	GS0214			
	产品图号 PART NO	GS0214-P-24			