

A

B

C

D

E

F

4

3

2

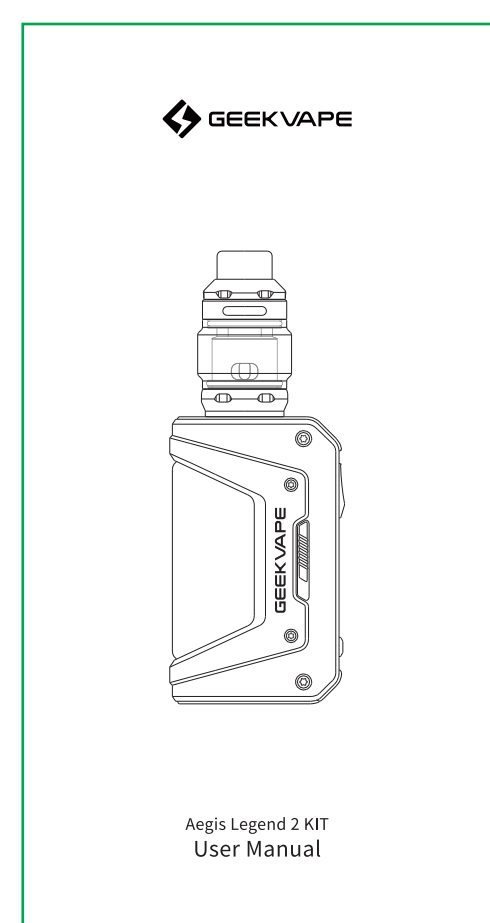

封面

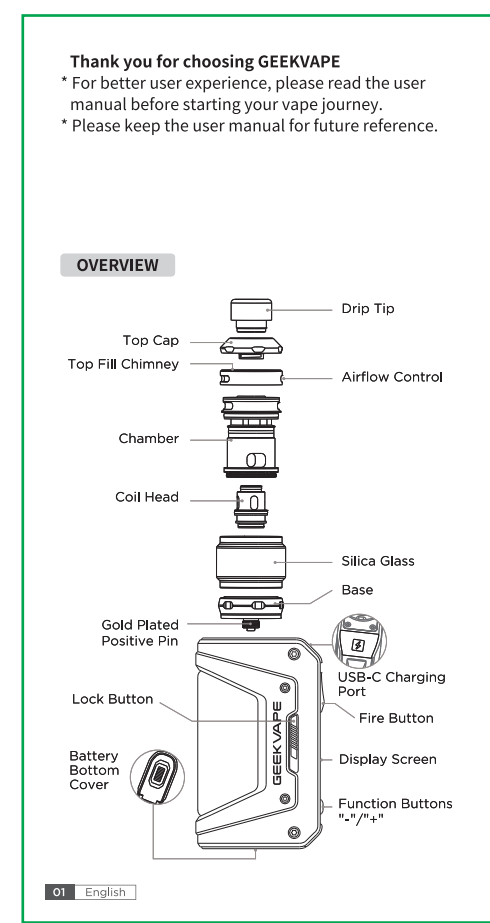

1

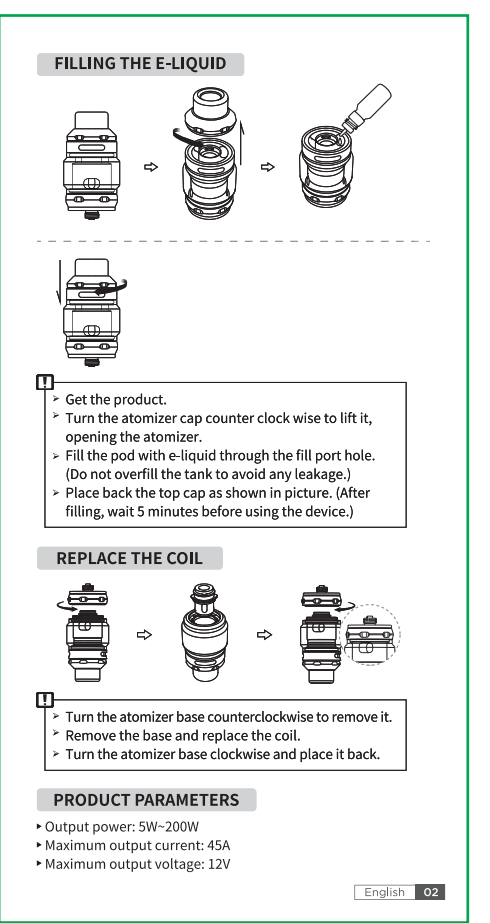

2

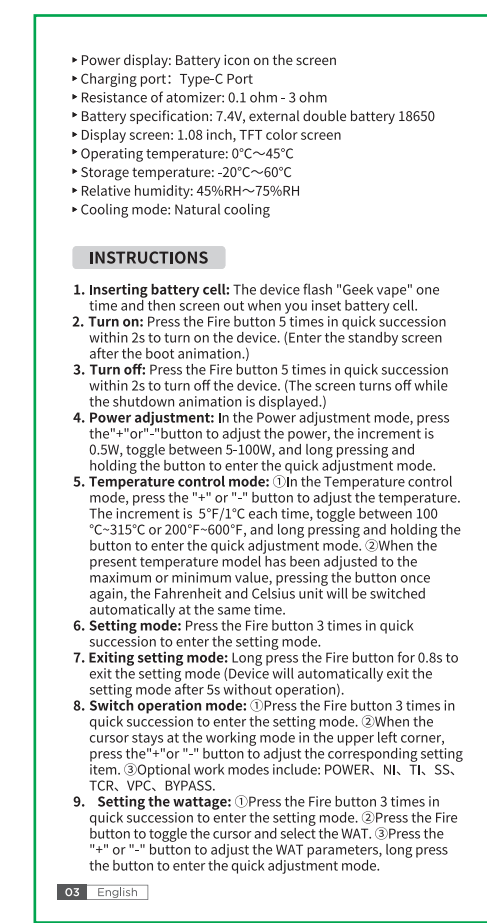

3

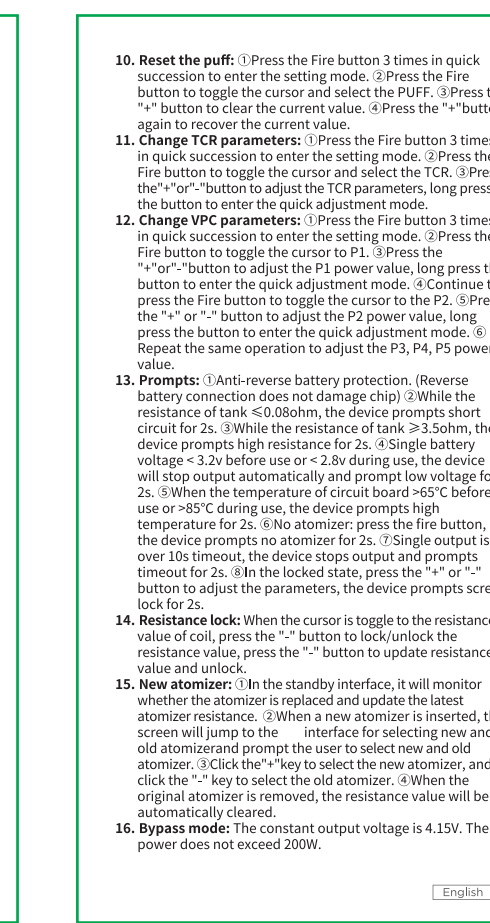

4

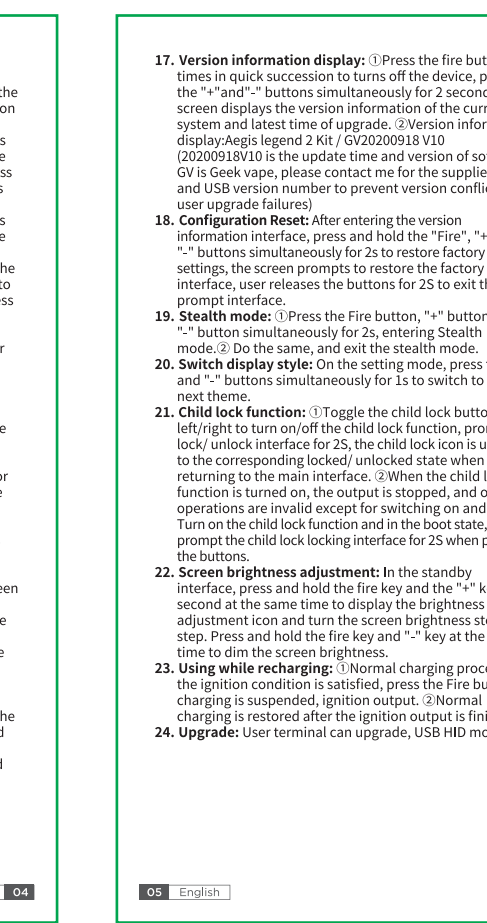

5

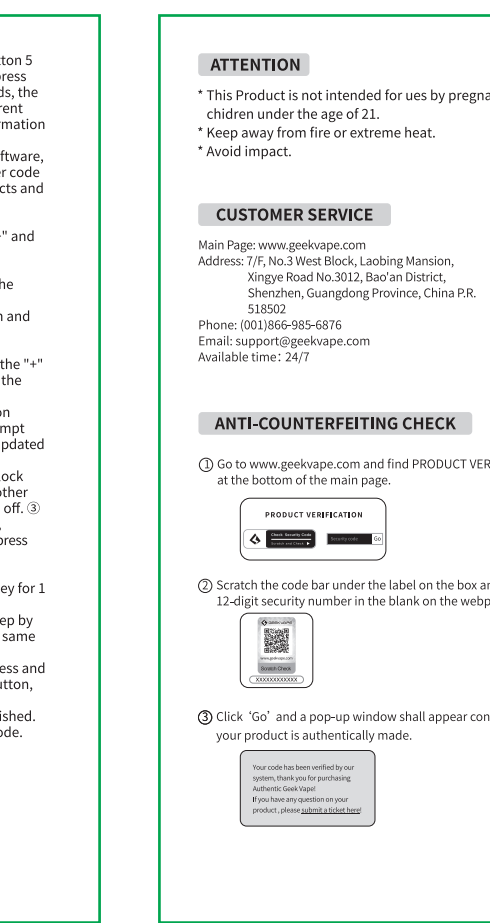

6

意大利语

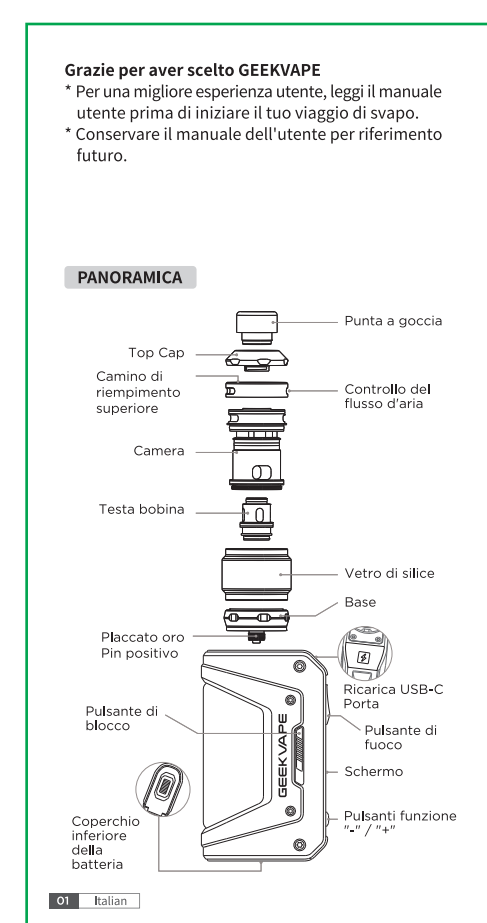

25

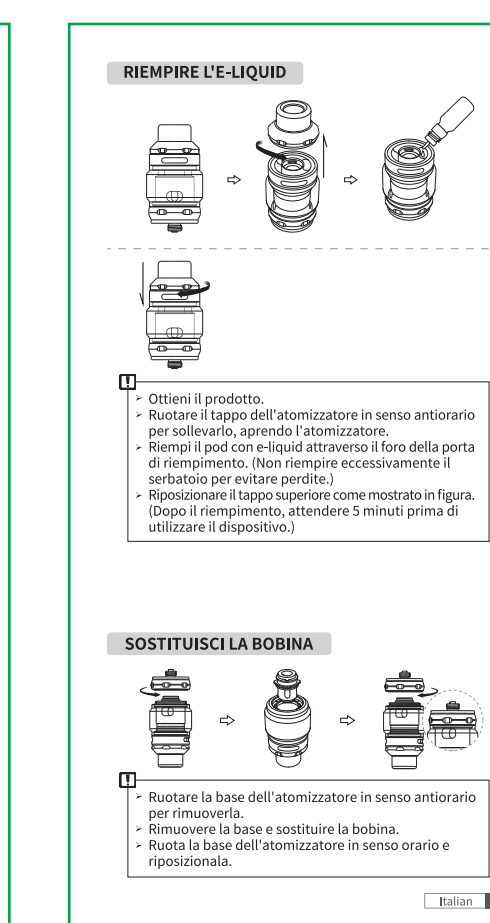

26



27

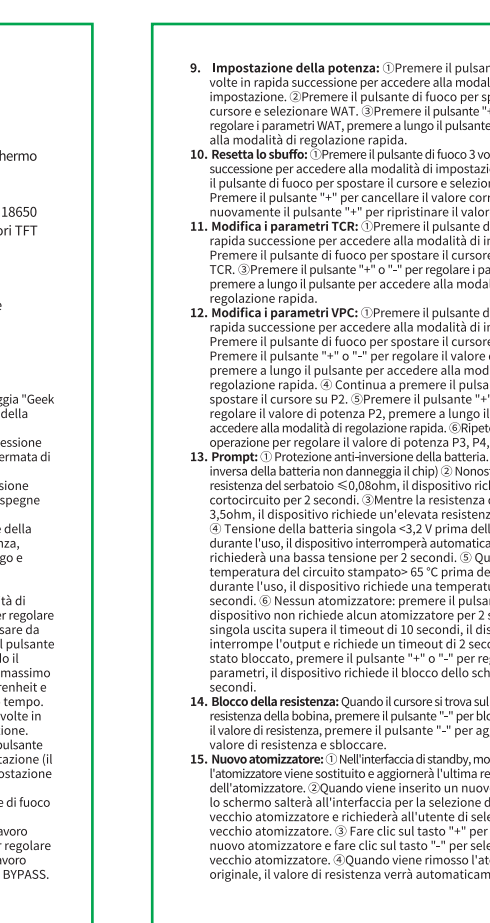

28

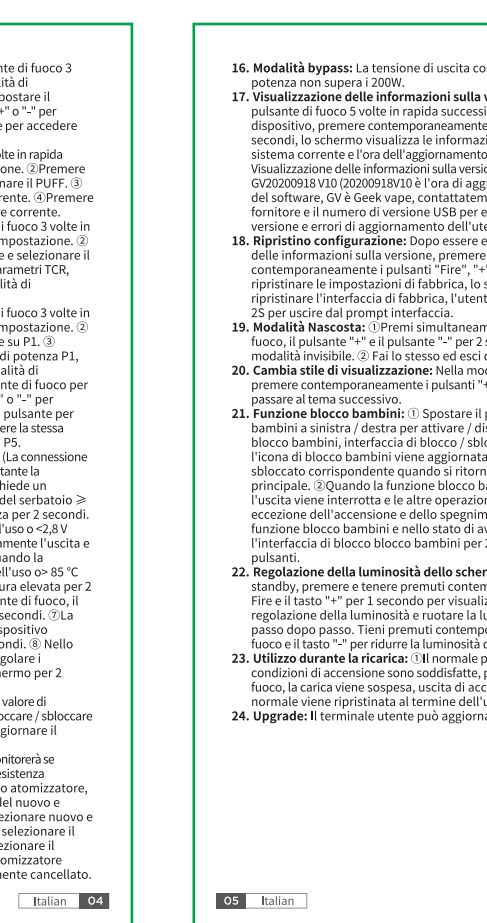

29

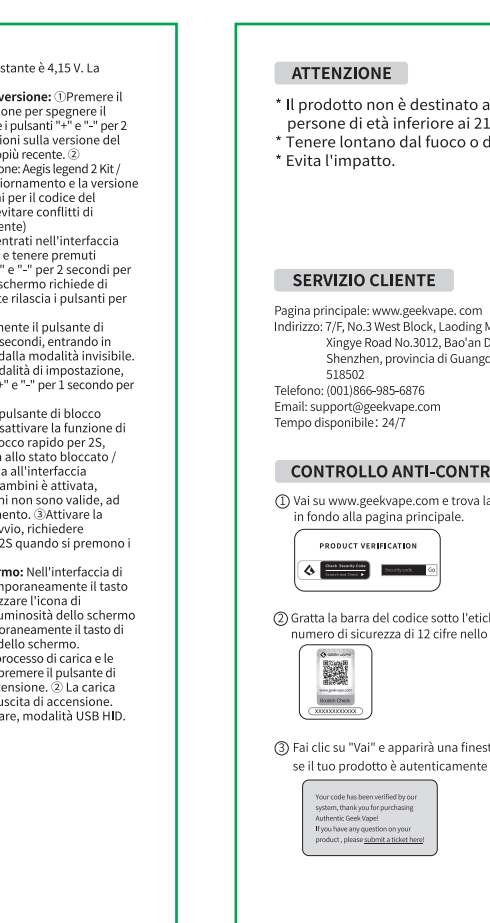

30

英语

俄语

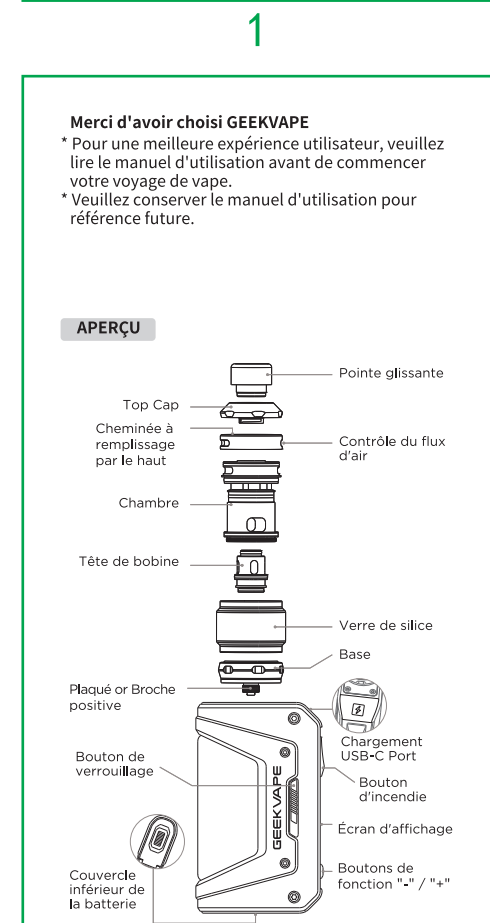

7

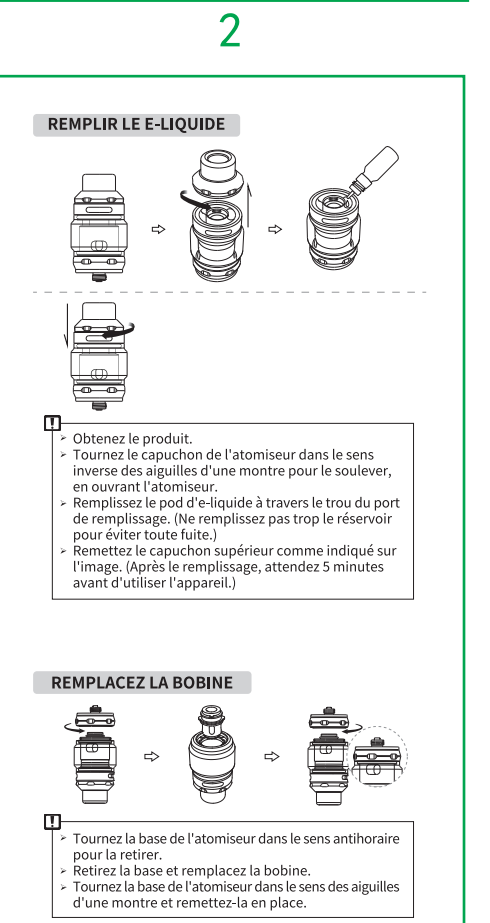

8

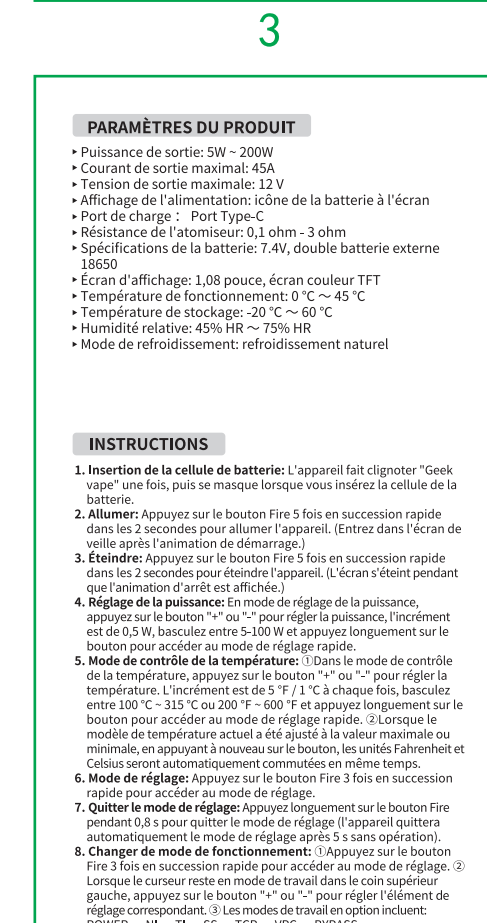

9

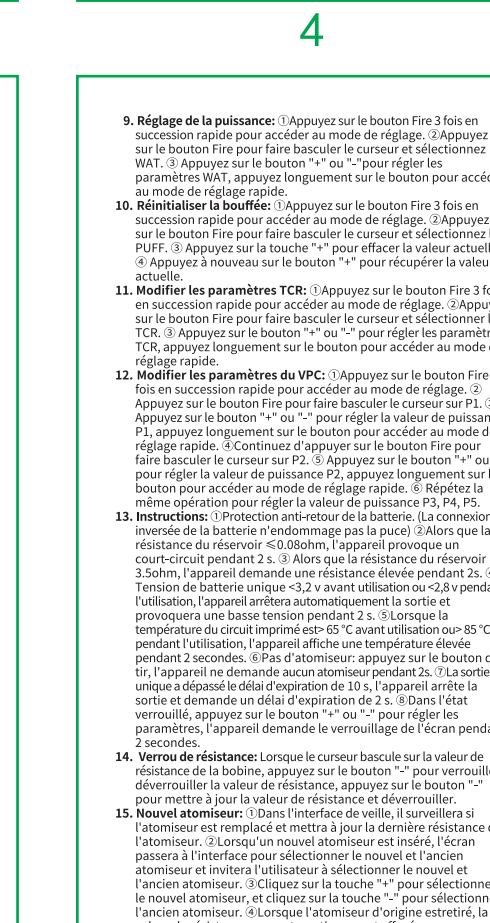

10

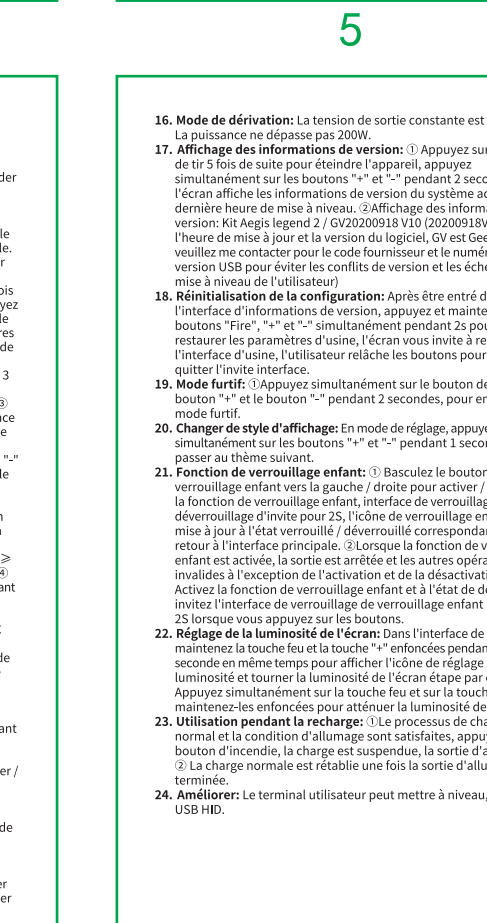

11

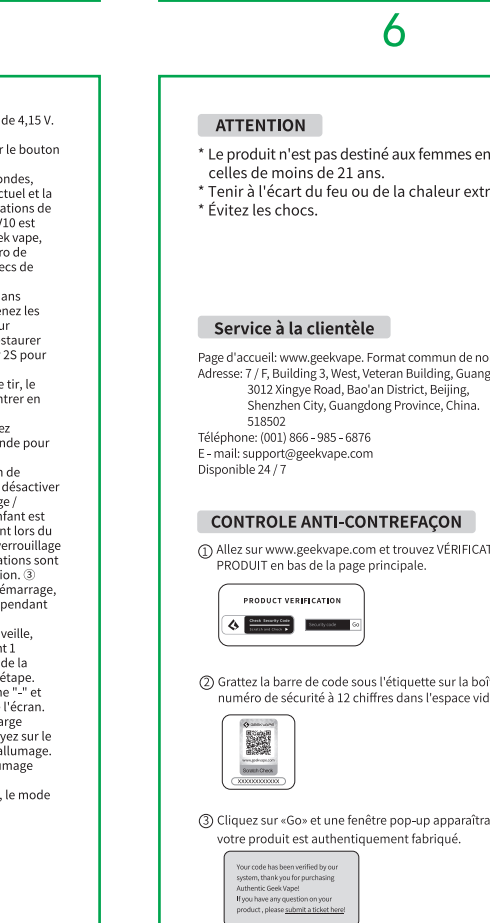

12

韩语

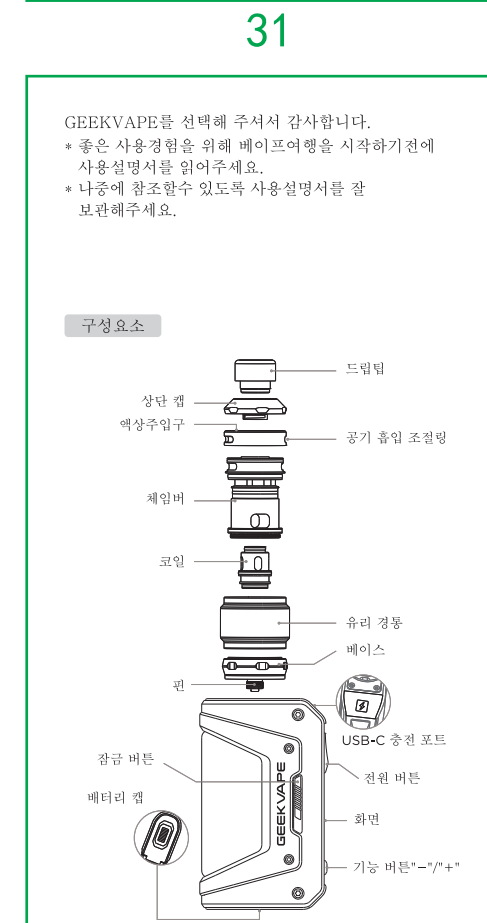

31

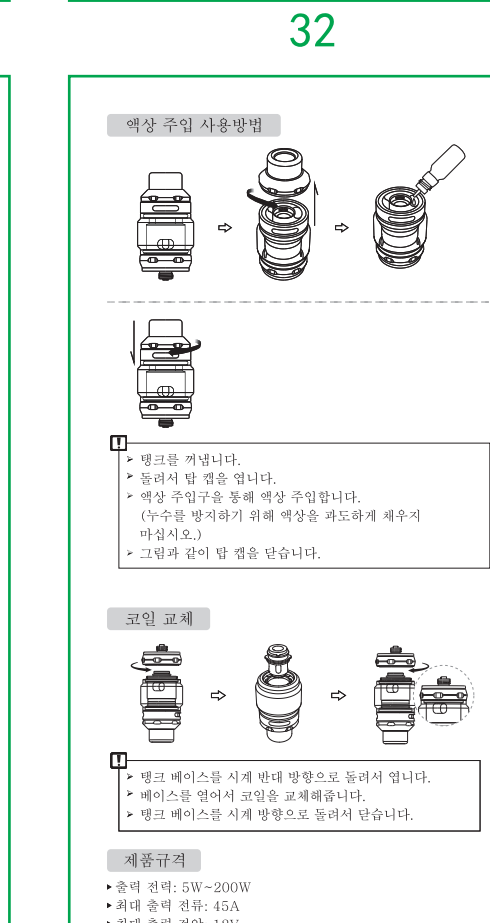

32

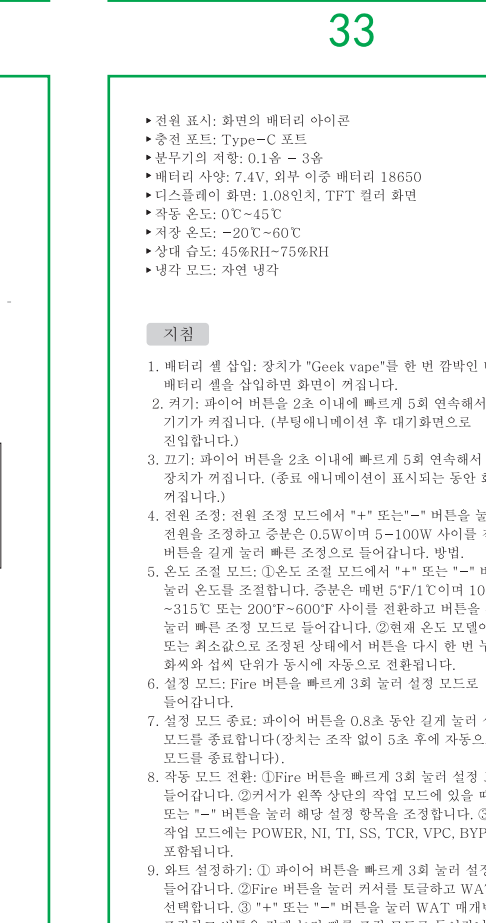

33

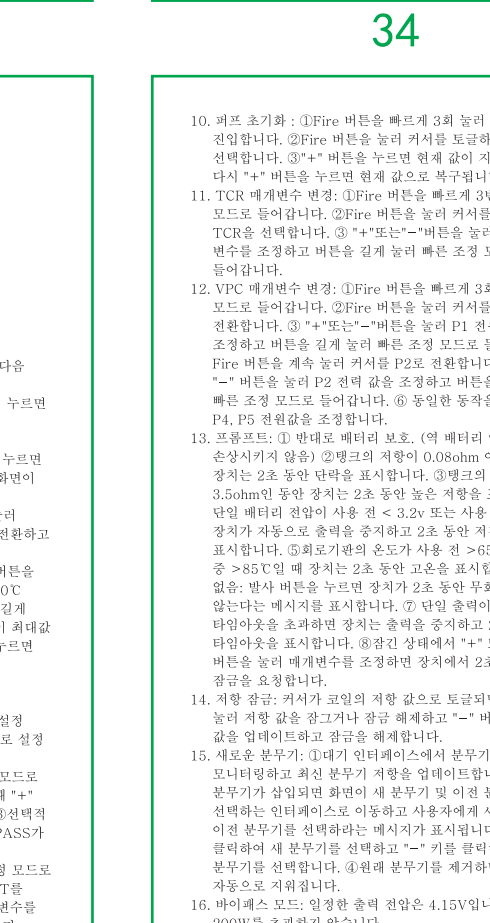

34

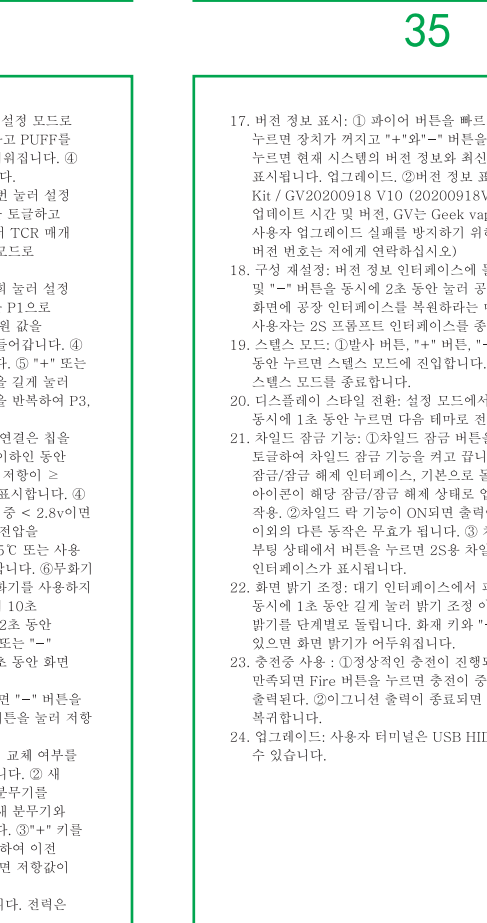

35

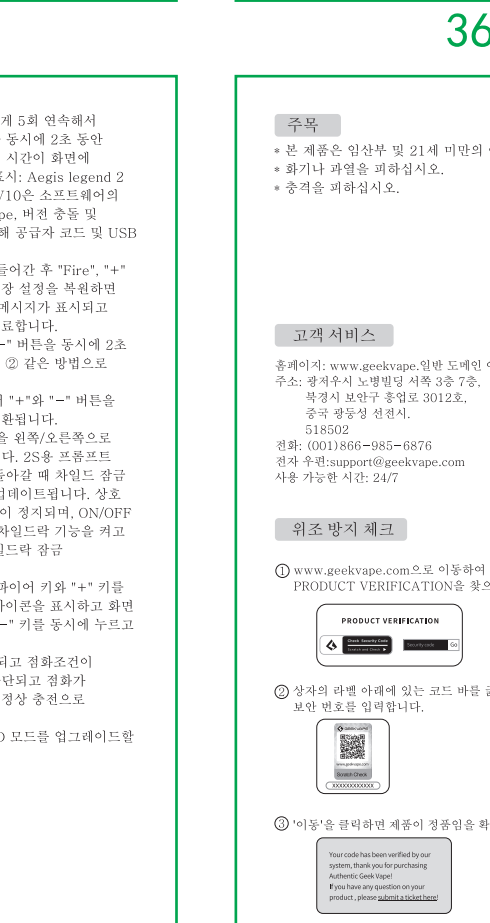

36

法语

荷兰语

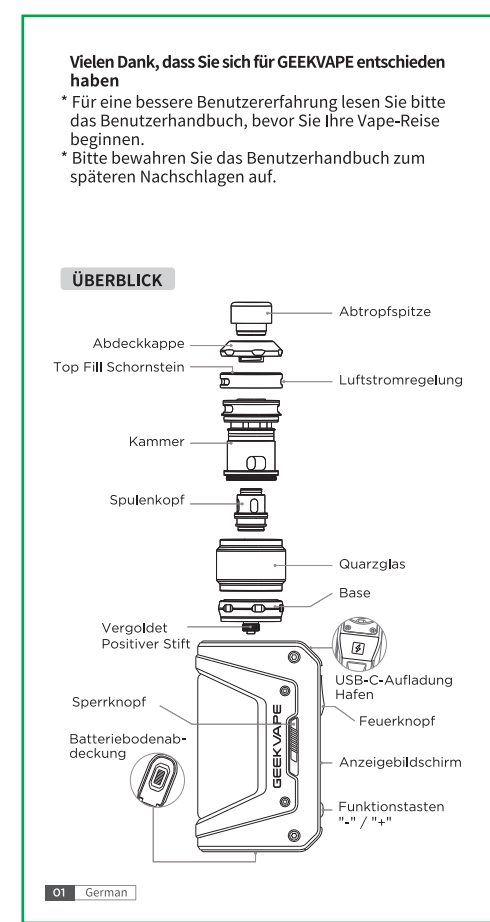

13

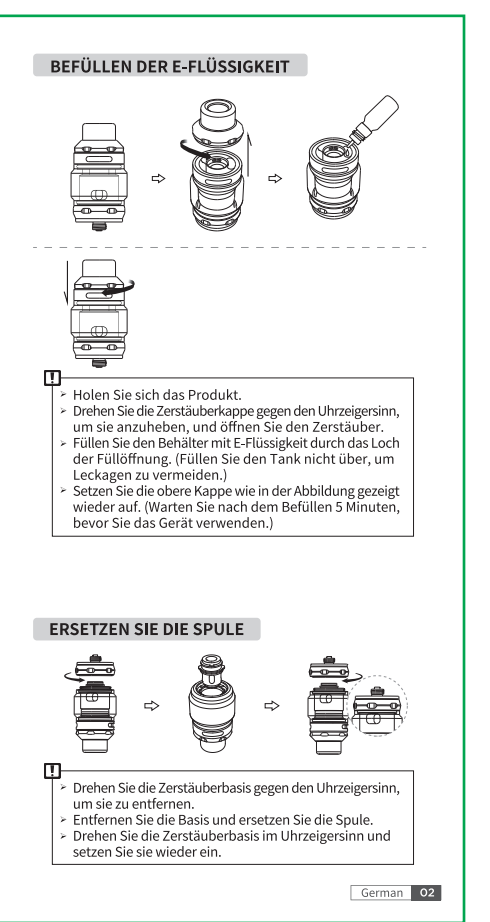

14

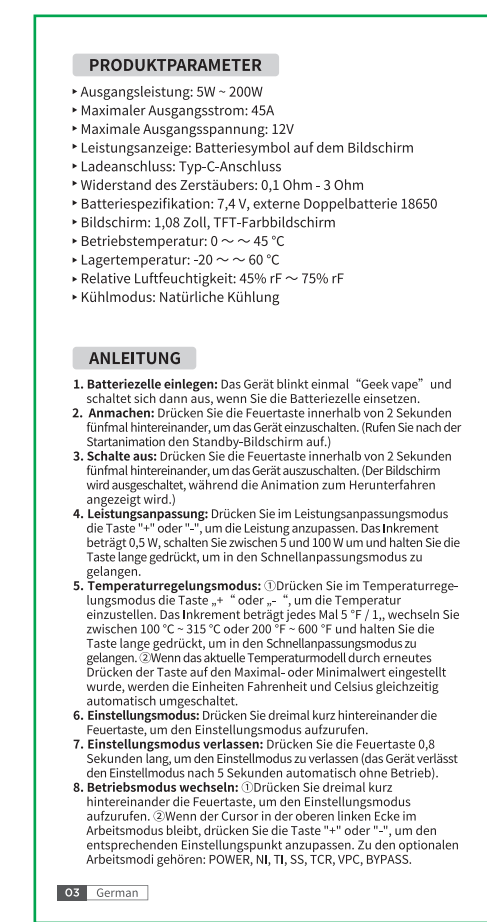

15

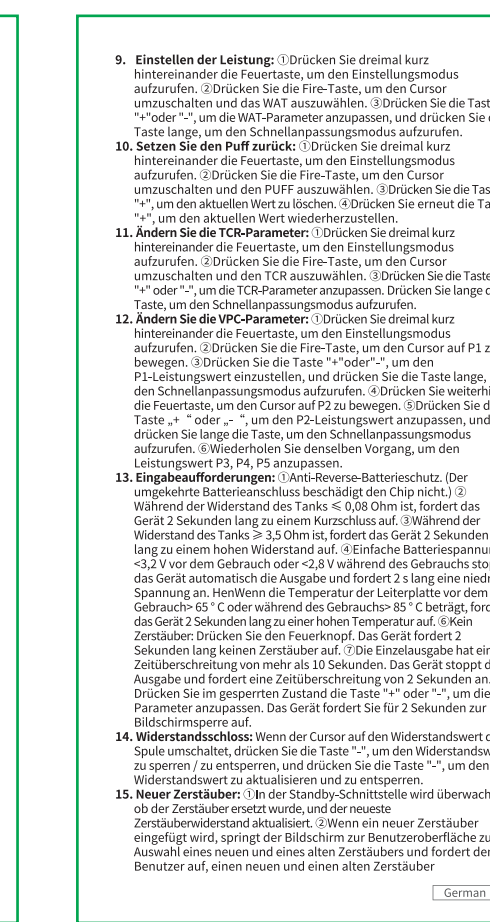

16

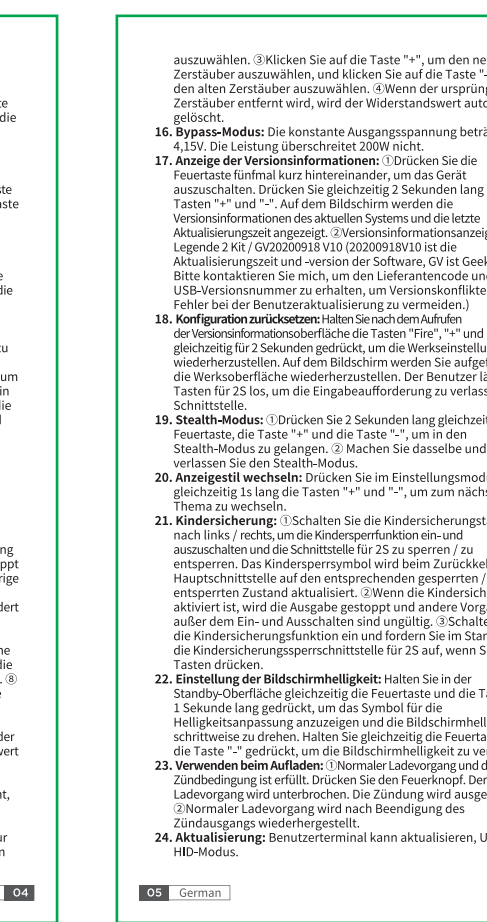

17

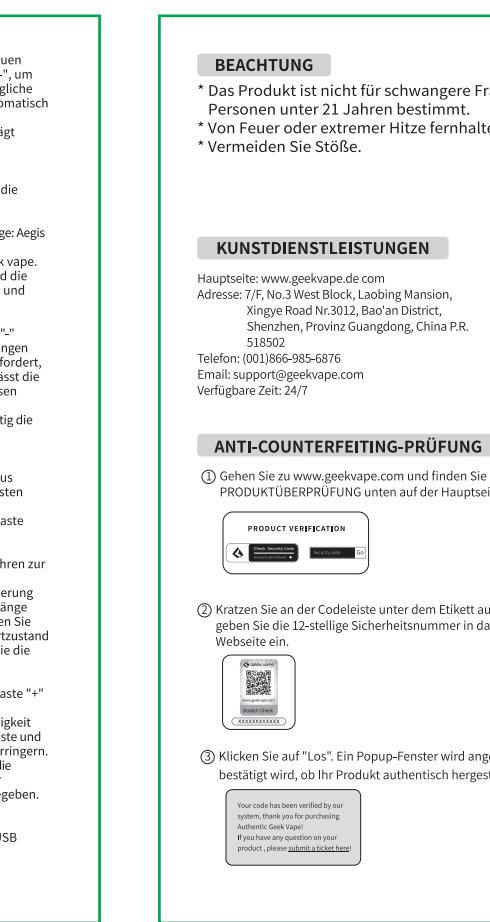

18

印尼语

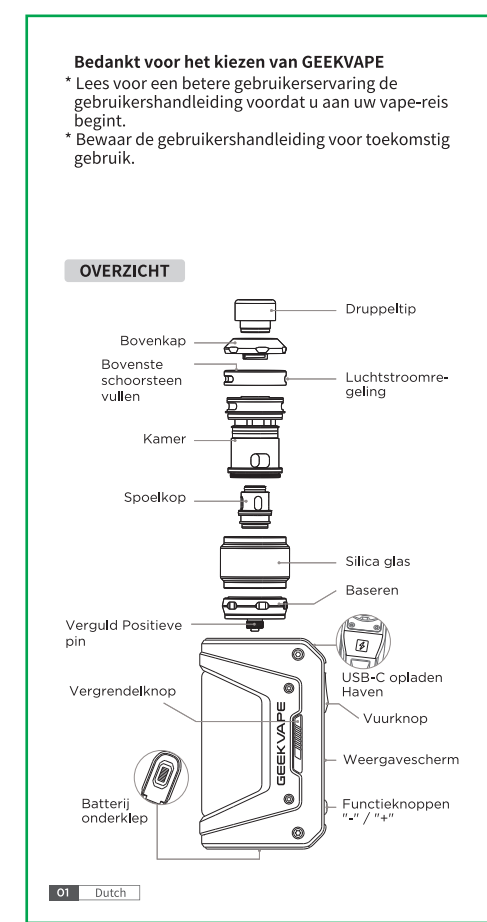

37

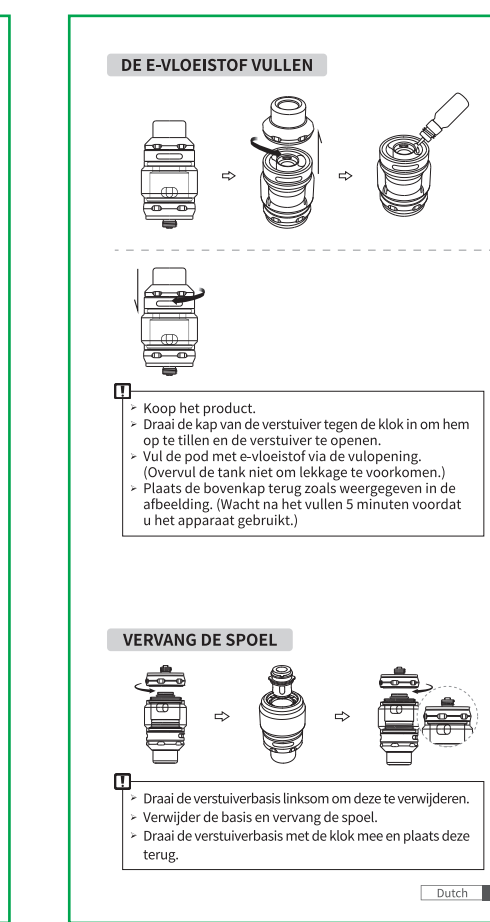

38

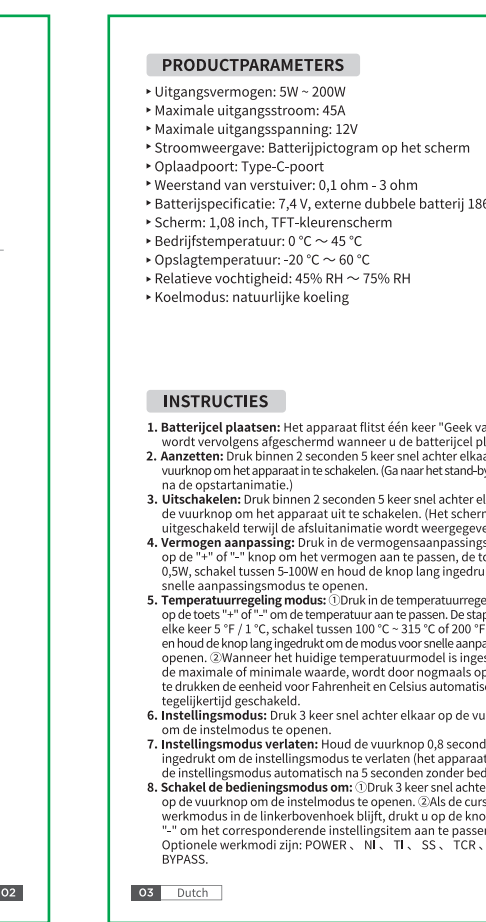

39

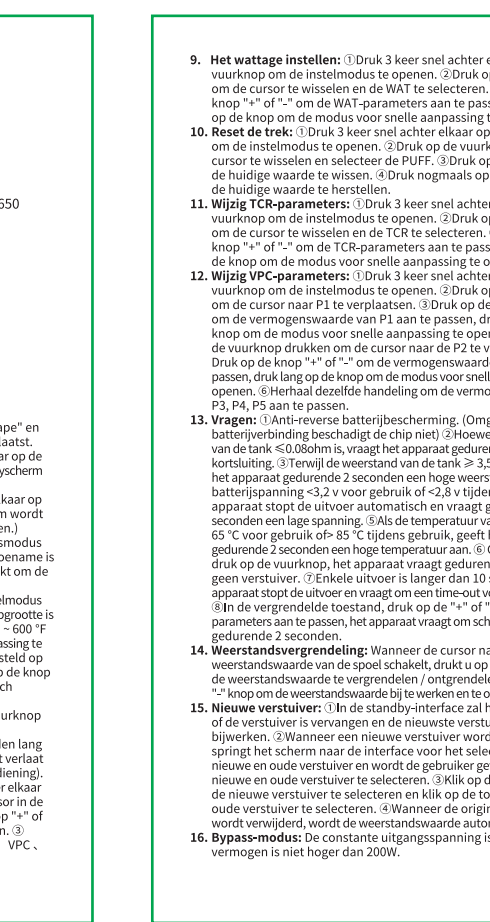

40

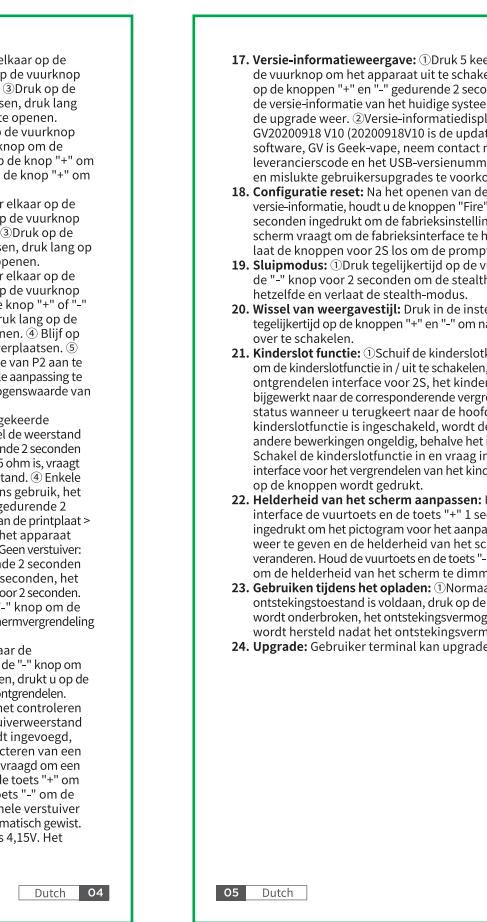

41

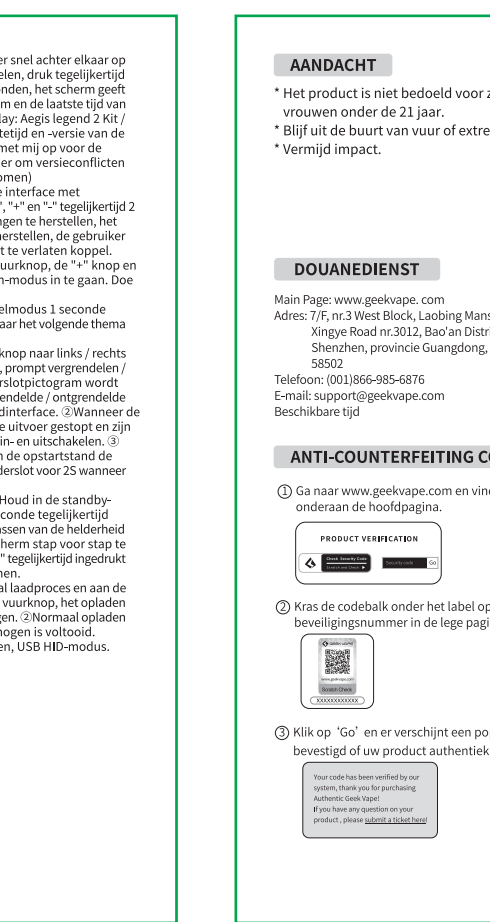

42

德语

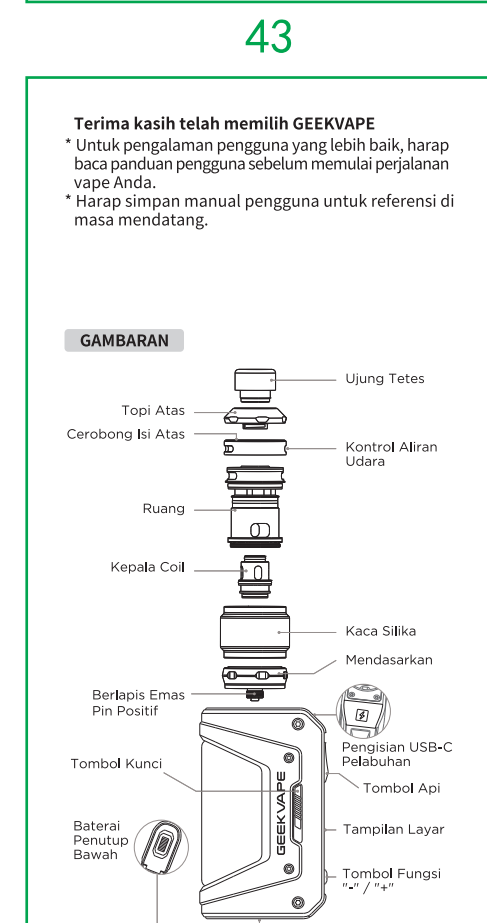

43

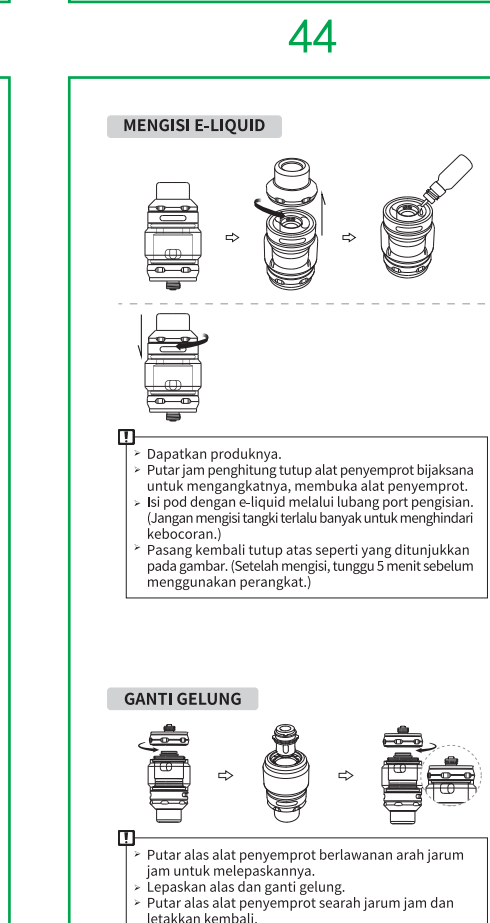

44

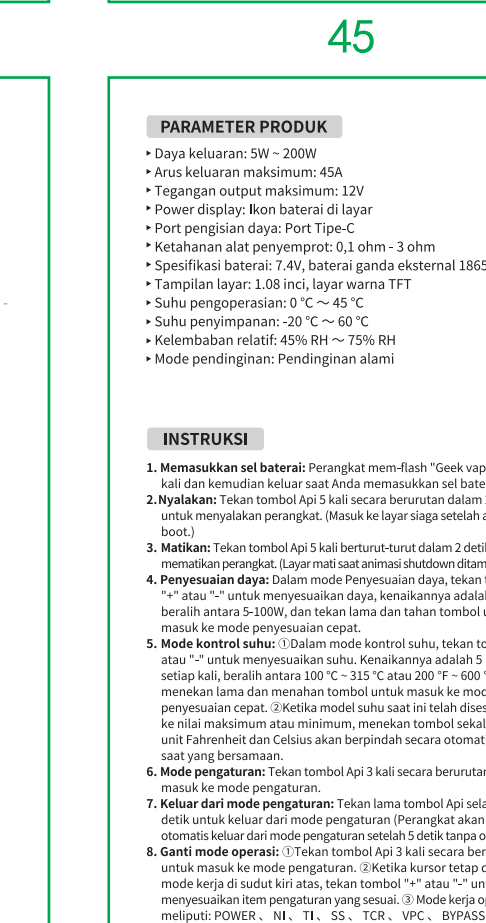

45

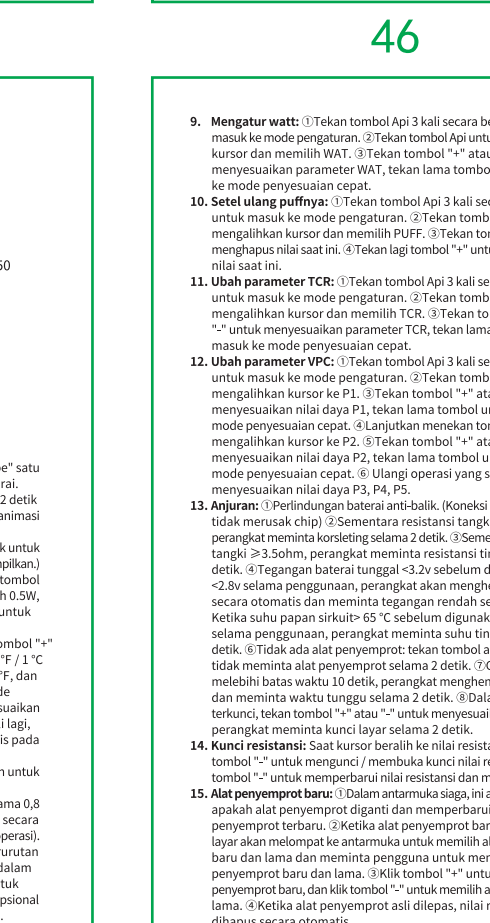

46



47



48

西班牙语



封底

要求:

1. 材料: 80g书写纸
2. 成品尺寸: 62*120mm ≤ 0.5
3. 工艺: 双面印刷 骑马订。
4. 颜色: 印单黑, 色差ΔE ≤ 1.00
5. 油墨, 要符合欧盟为RoHS环保标准。
6. 页码顺序依次按封面、1、2...53、54、封底
印刷以文件为准, 严格按图纸做货。裁切边缘须整齐无毛边。

A2版更改内容:
1、改尺寸
2、丹麦语改成韩语

深圳市基克纳科技有限公司
Geekvape Technology co, LTD

未标公差 OTHER TOLERANEC	产品名称 PRODUCTNAME	Aegis Legend 2 KIT - 说明书 A2
	产品编码 PART NO	GS0028
	产品图号 PART NO	GS0028-P-11

绘图
PRODUCTNAME

魏鹏
2022/1/20

比例 1:1
SCALE

审核
CHECKED

UNIT(单位): mm

REV(版本): A2

核准
APPROVED

