

A

B

C

D

E

F

4

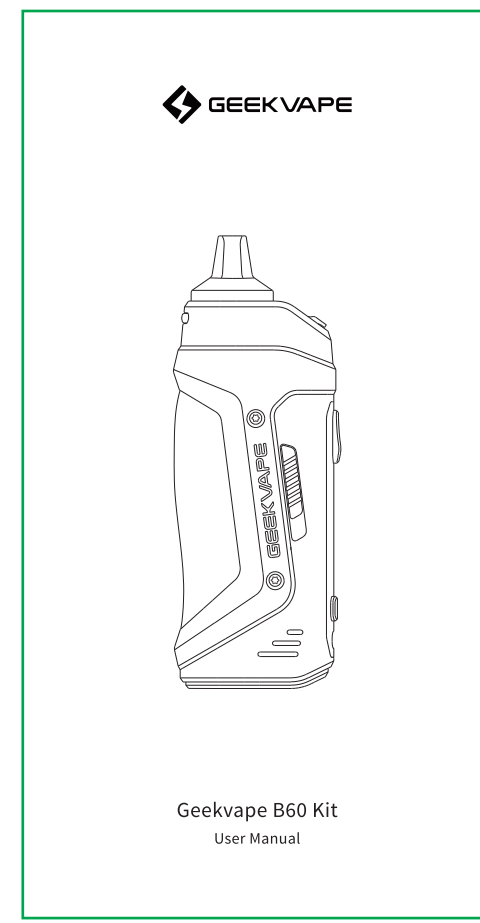

封面

英语

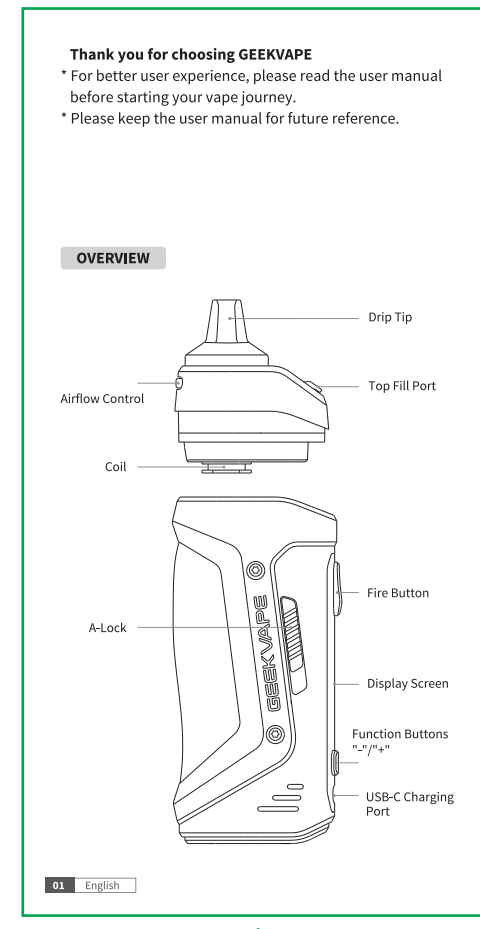

1

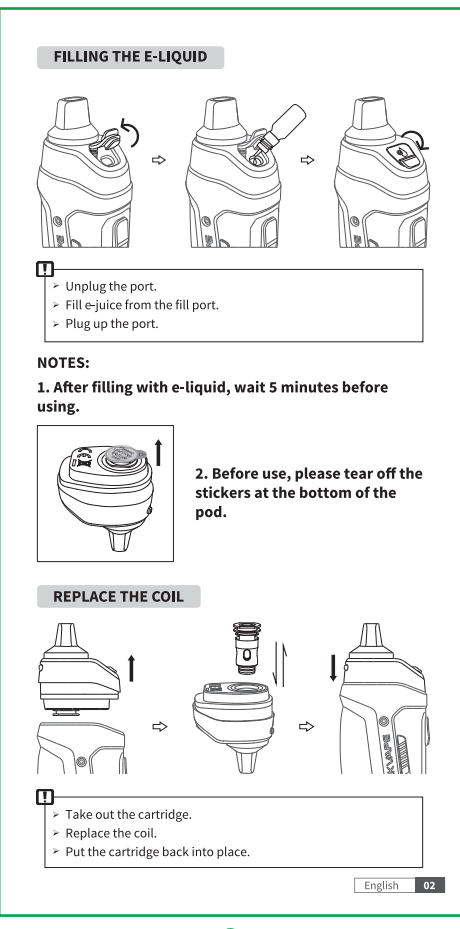

2

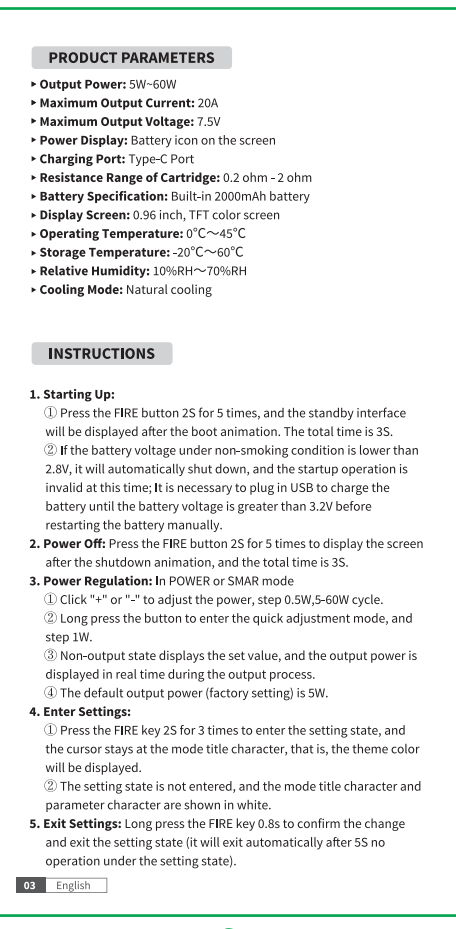

3

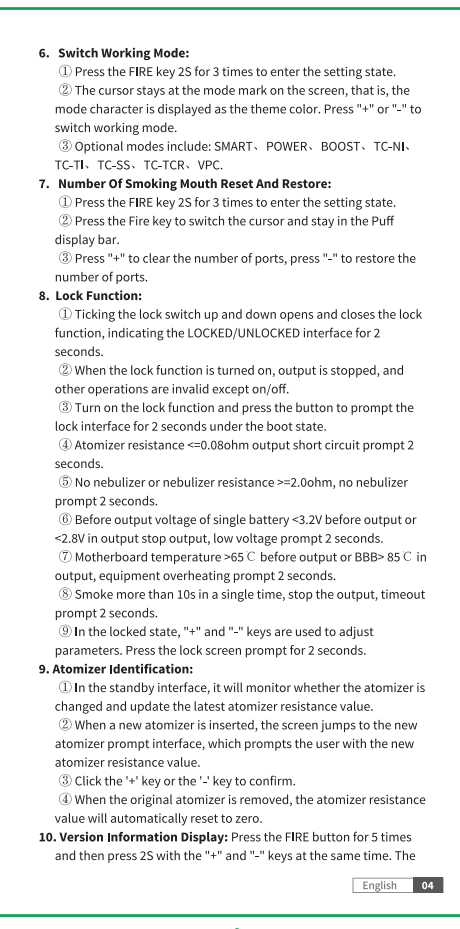

4

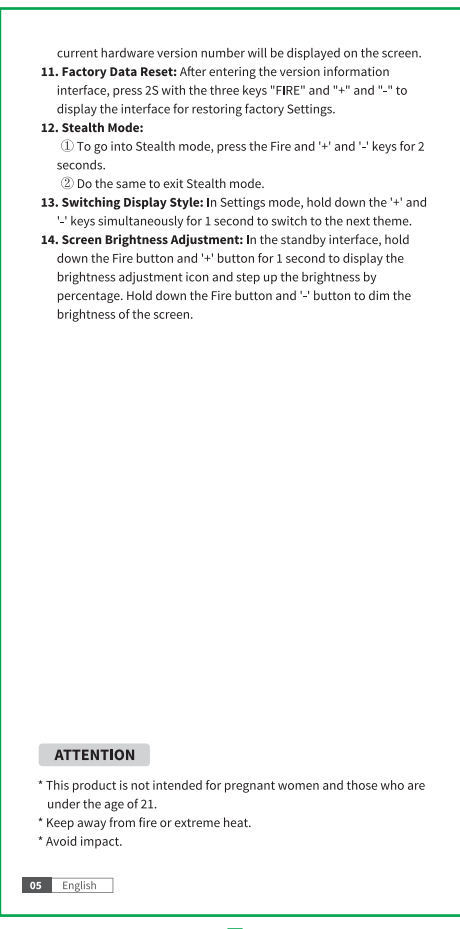

5

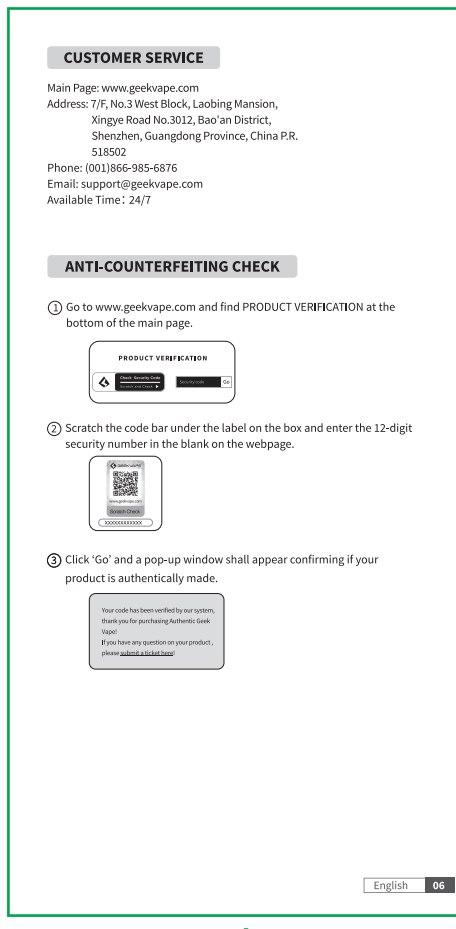

6

意大利语

俄语

韩语

荷兰语

印尼语

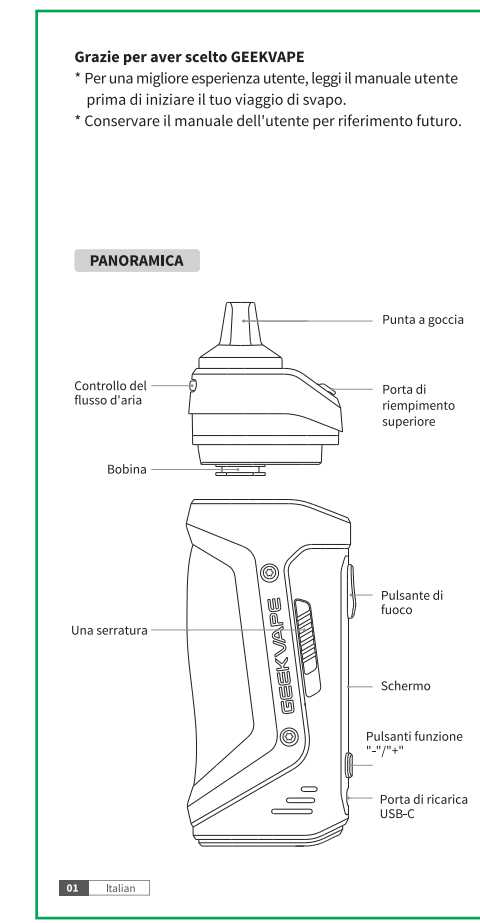

25



26

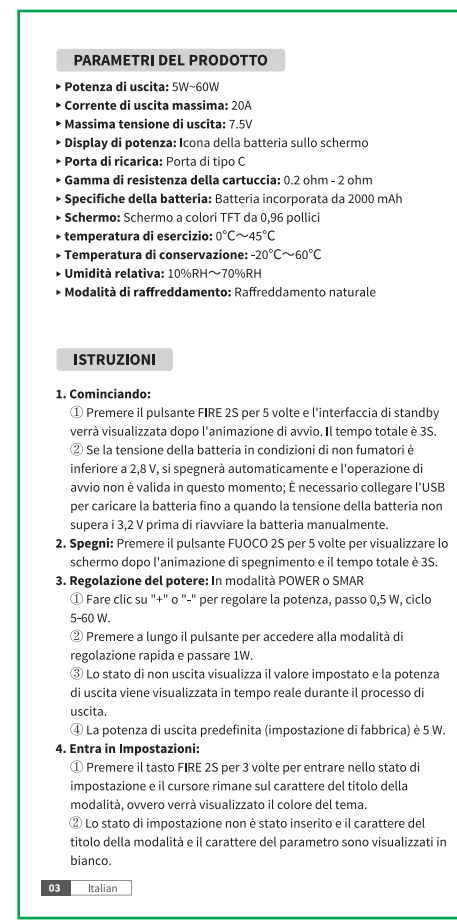

27

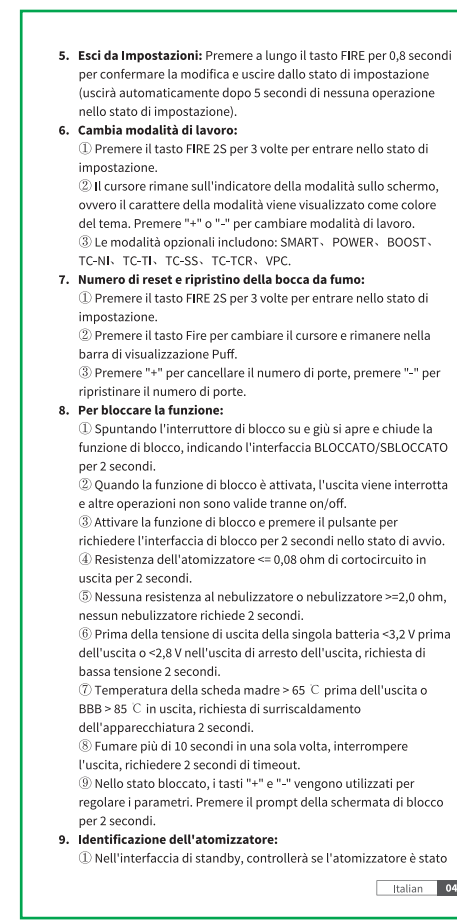

28

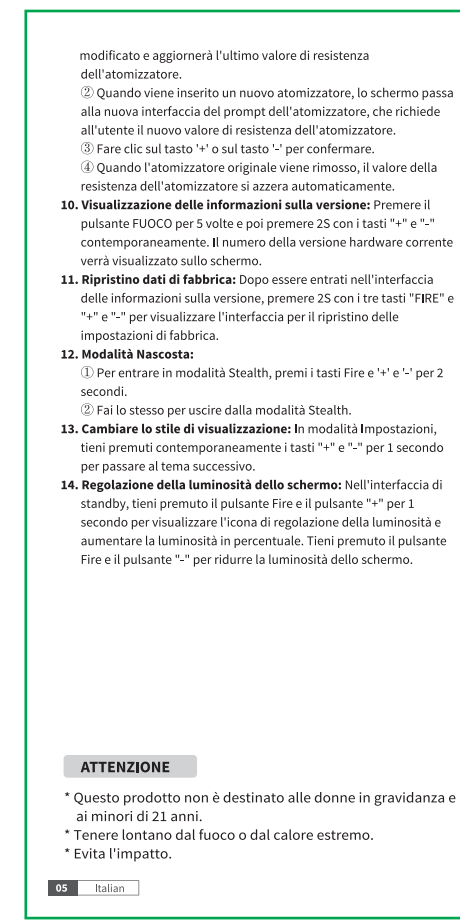

29

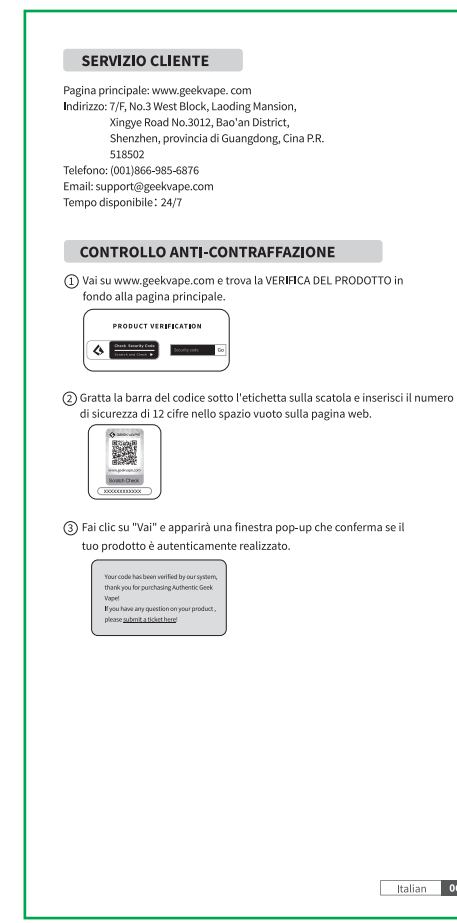

30

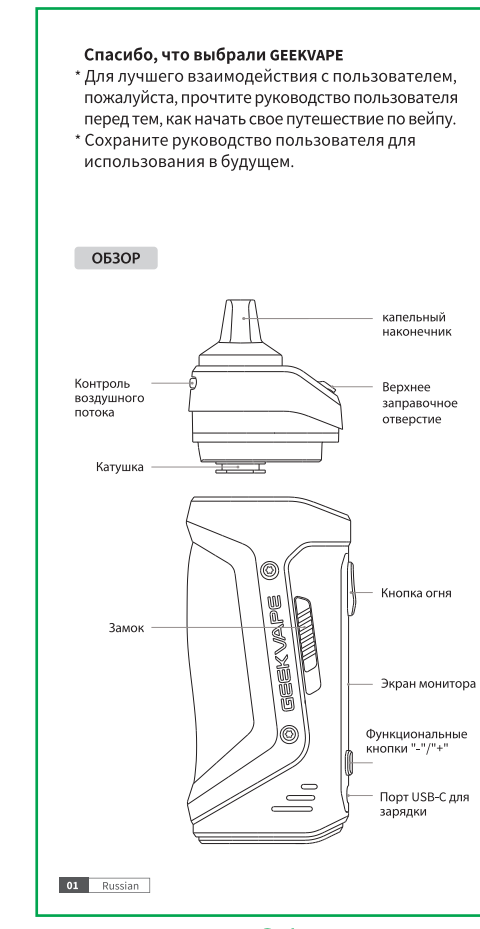

31



32

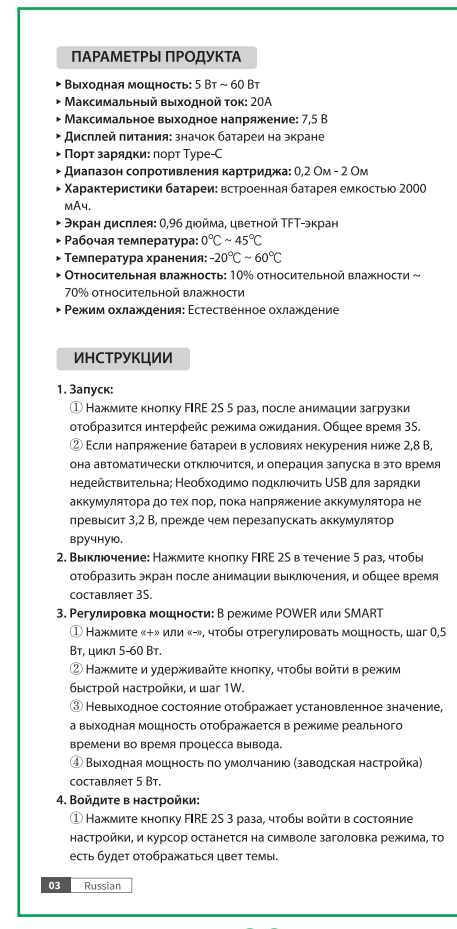

33

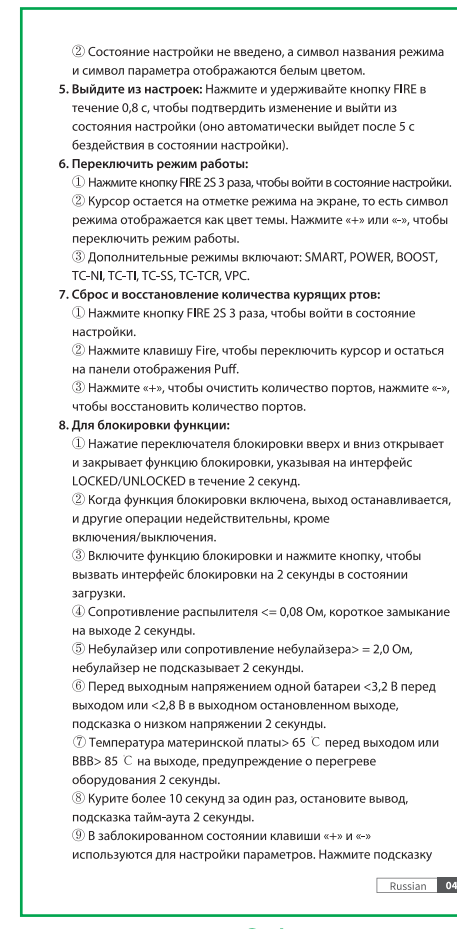

34

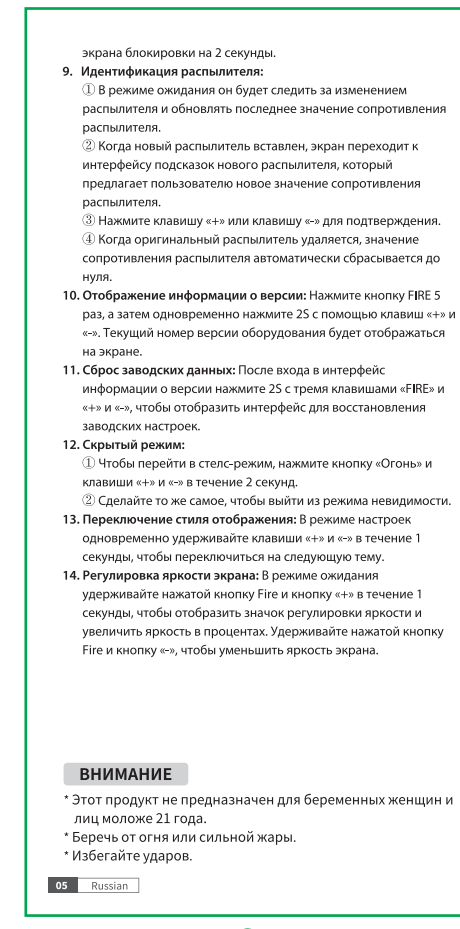

35

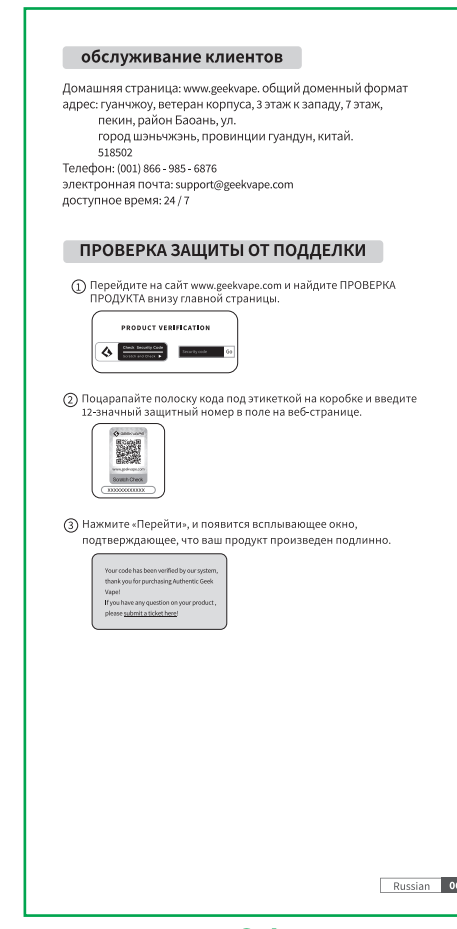

36

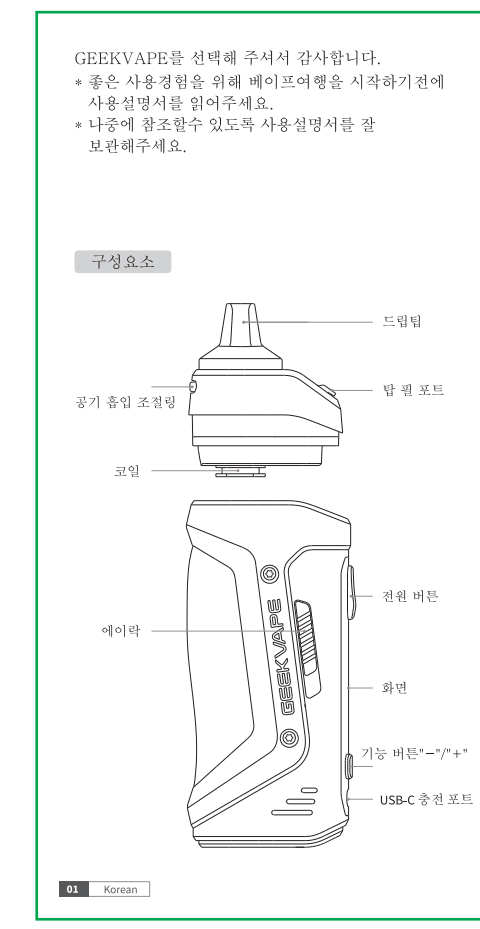

37

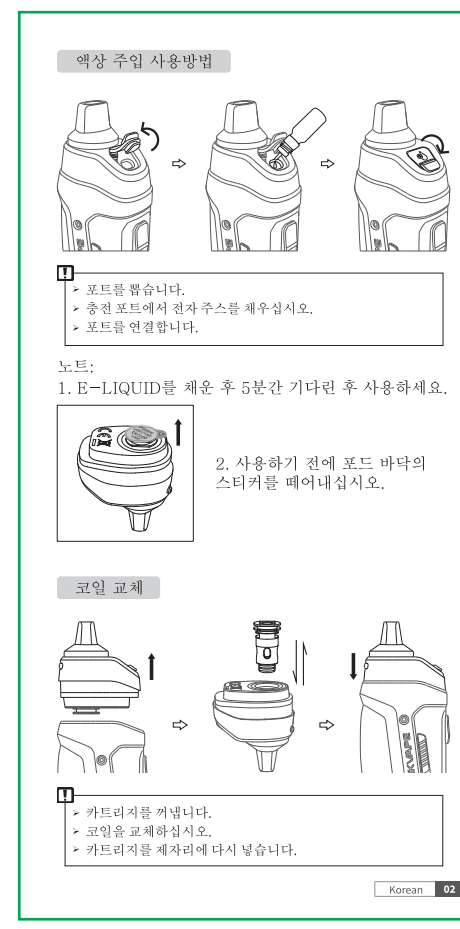

38

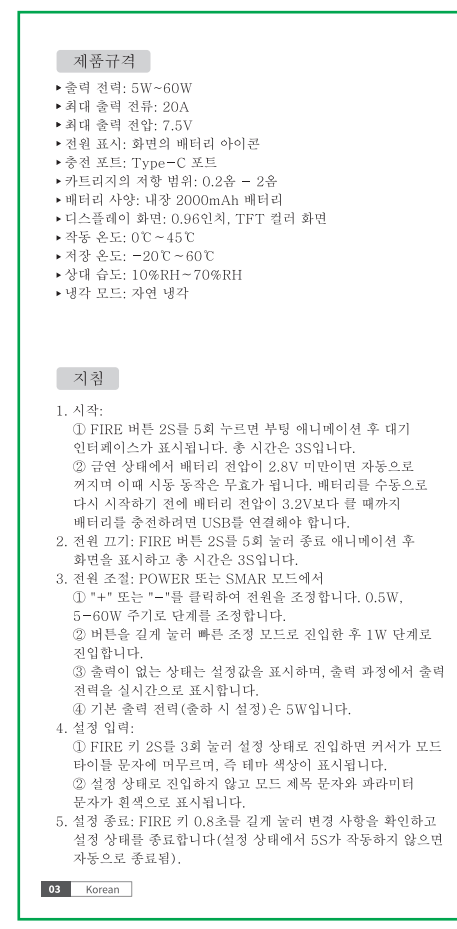

39

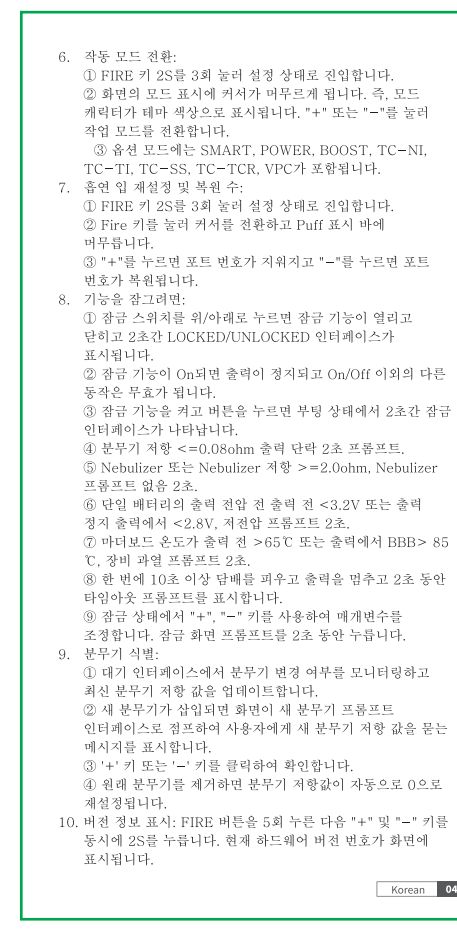

40

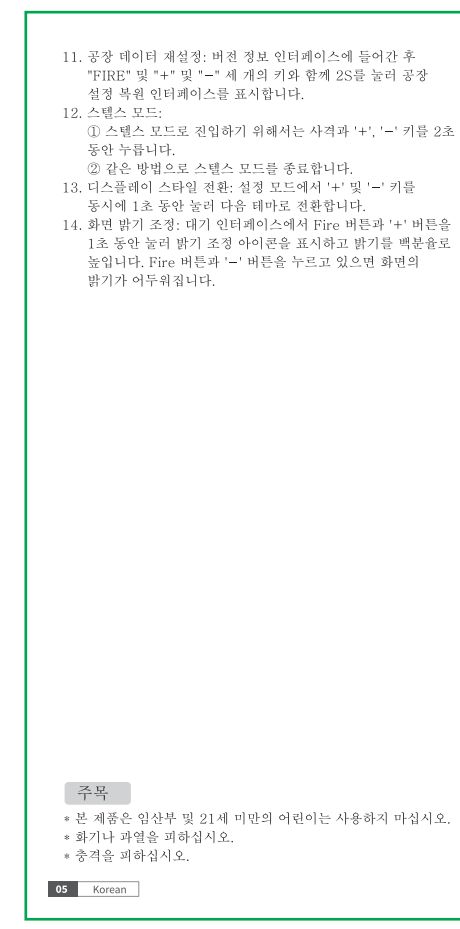

41

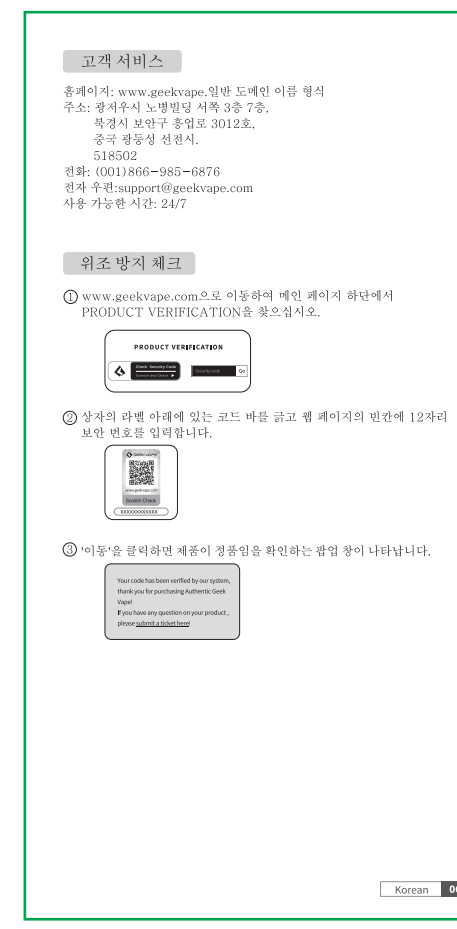

42

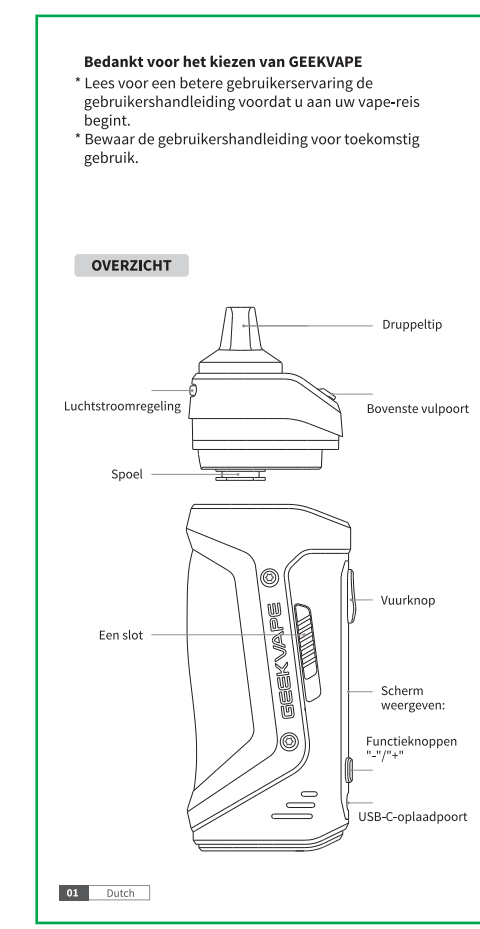

43



44

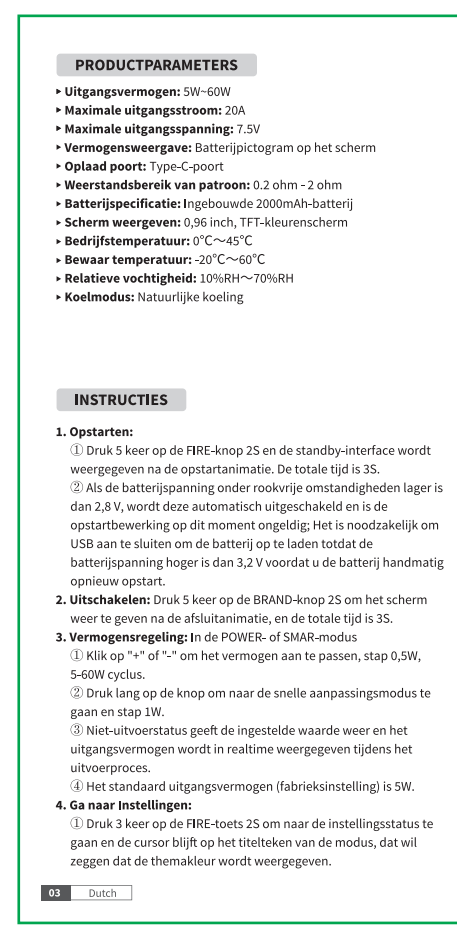

45

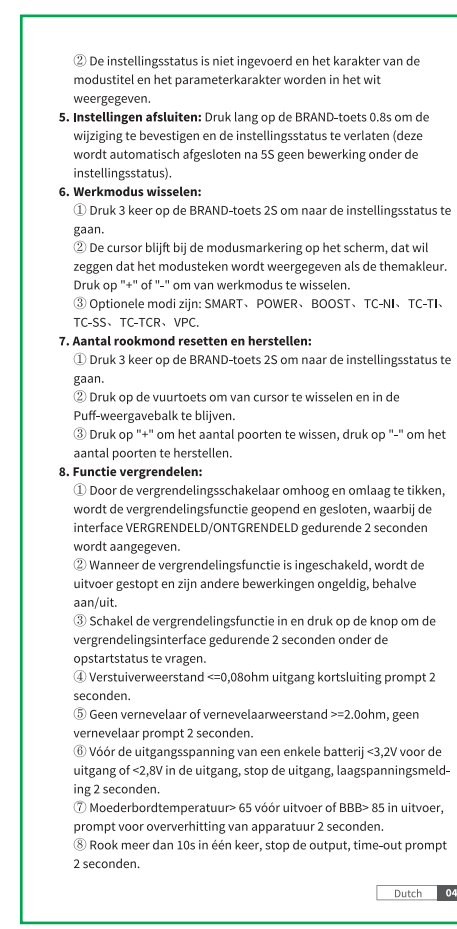

46

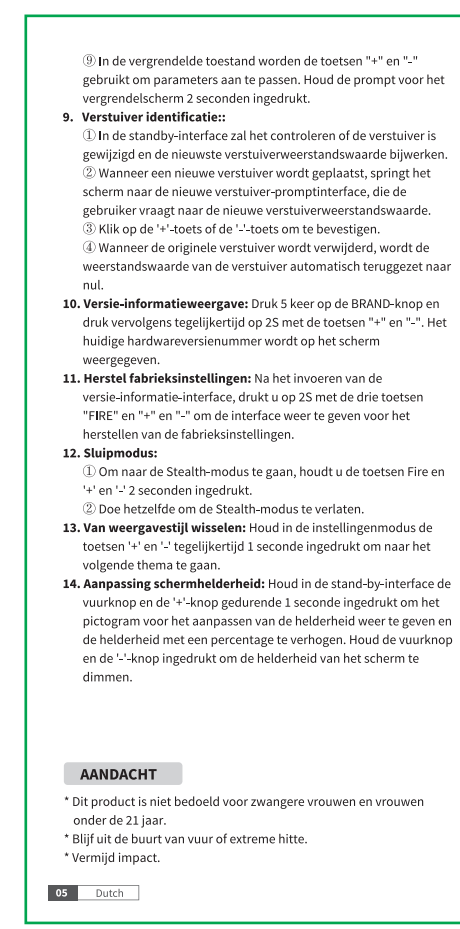

47

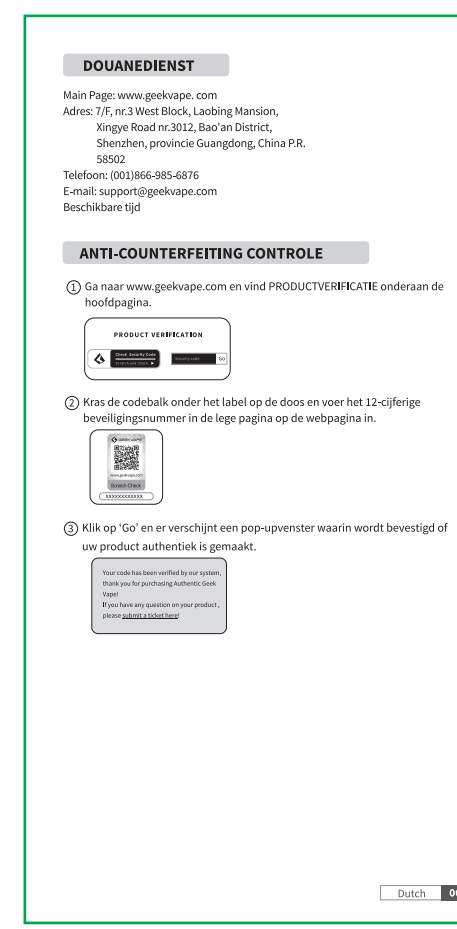

48

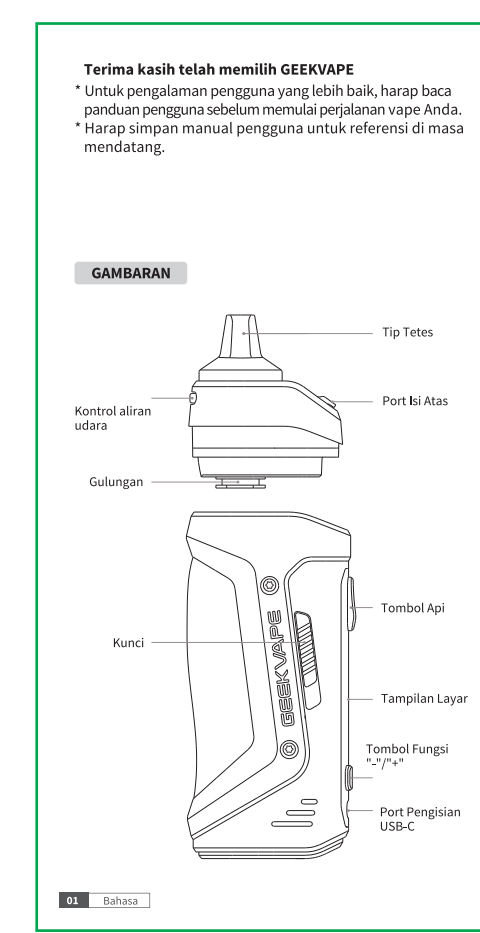

49

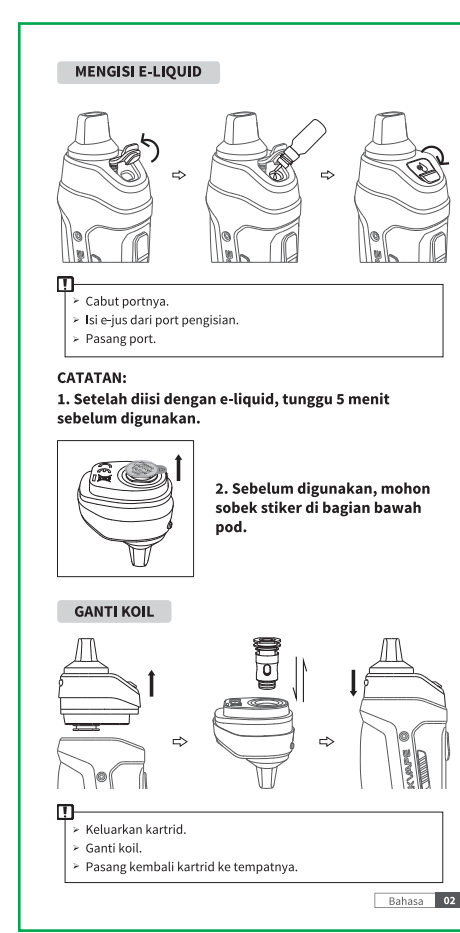

50

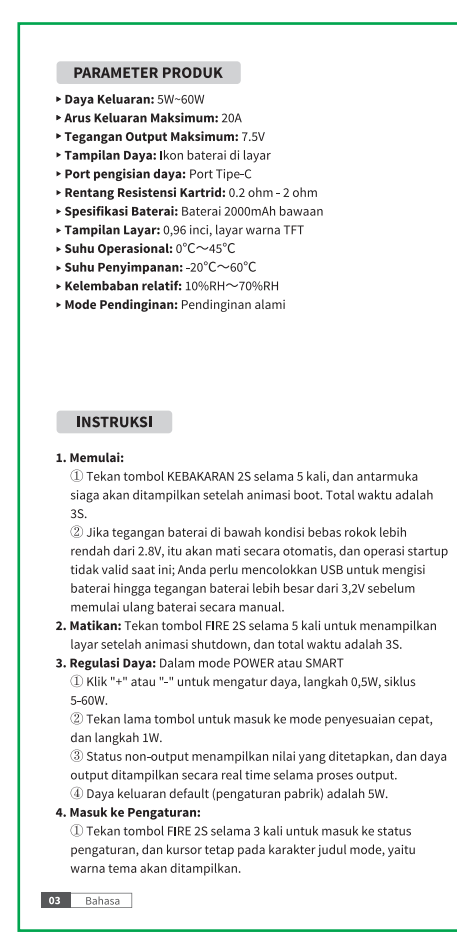

51

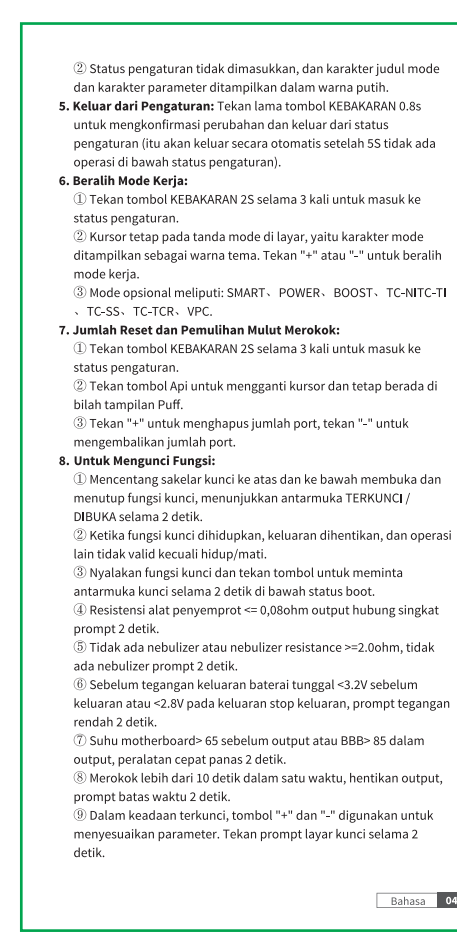

52

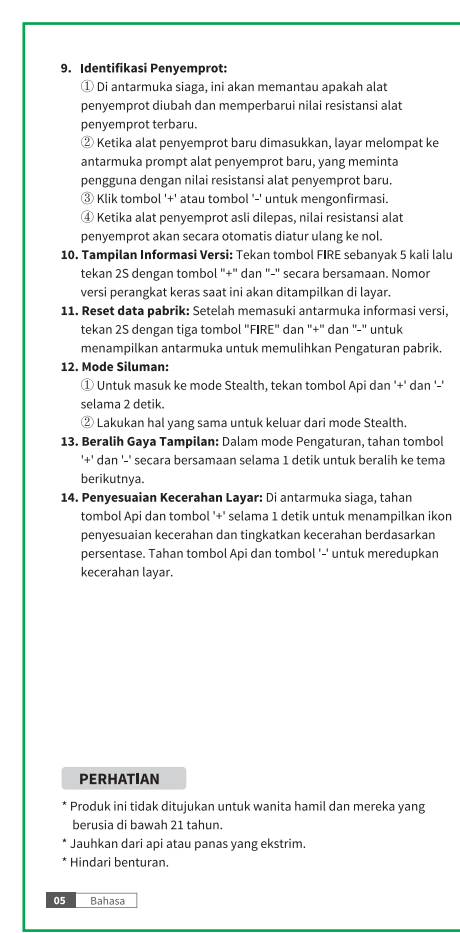

53

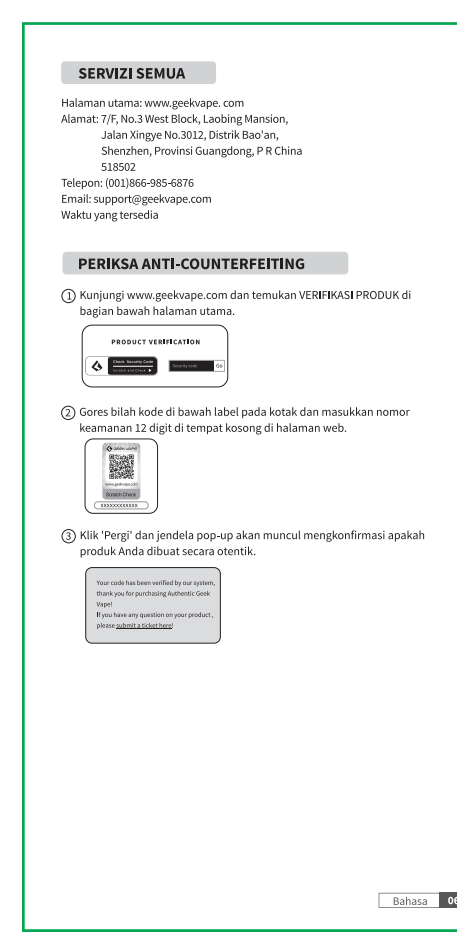

54



封底

3

法语

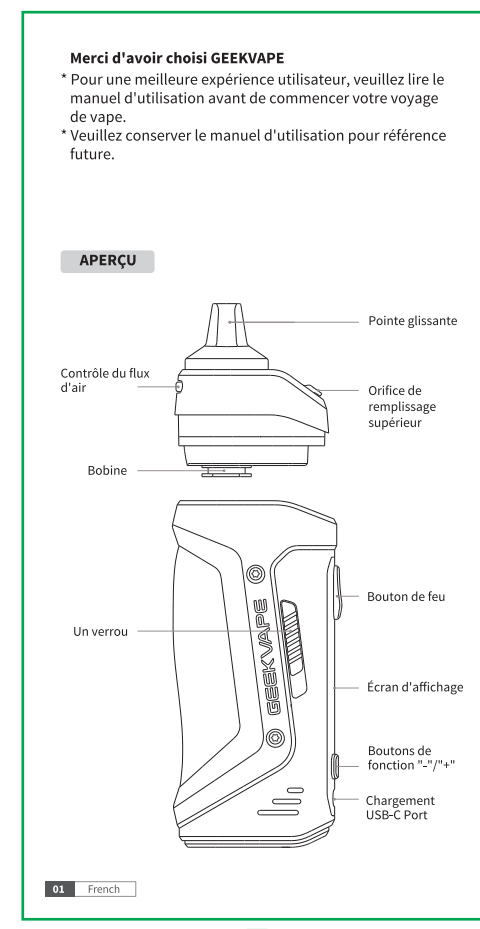

7

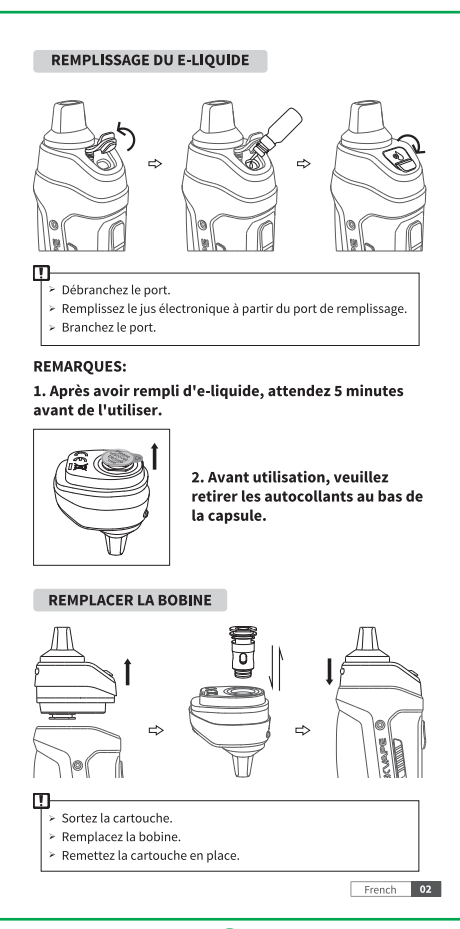

8

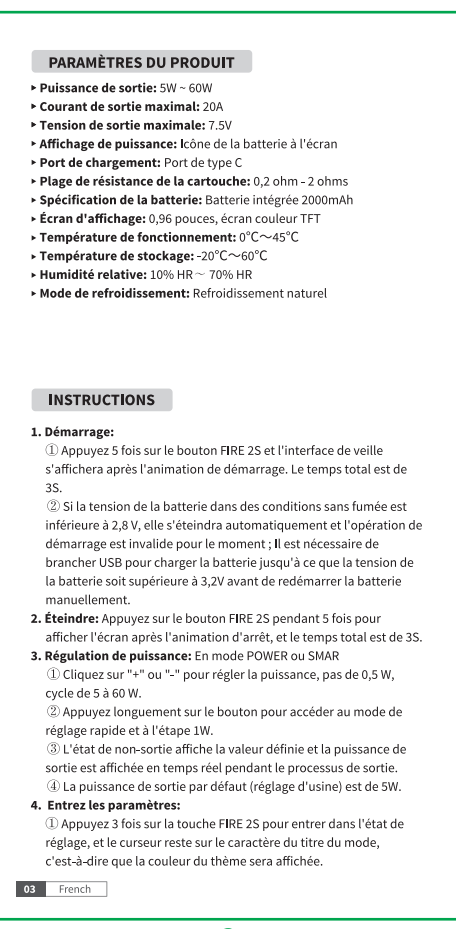

9

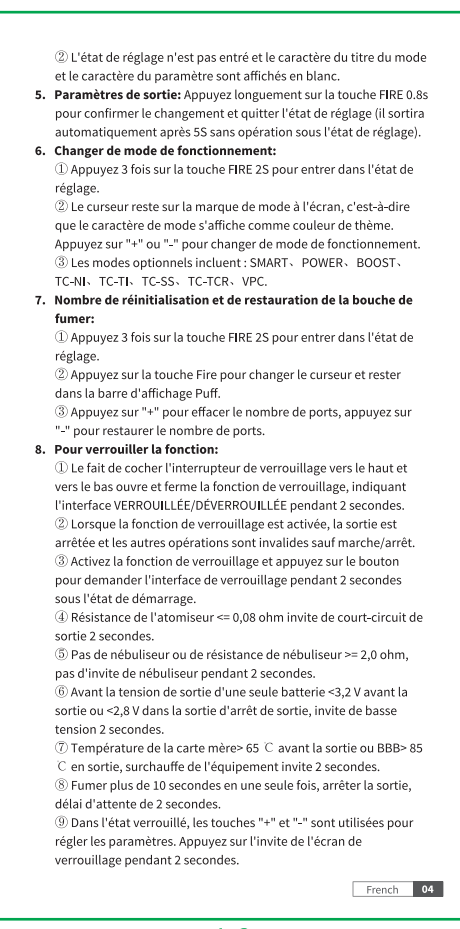

10

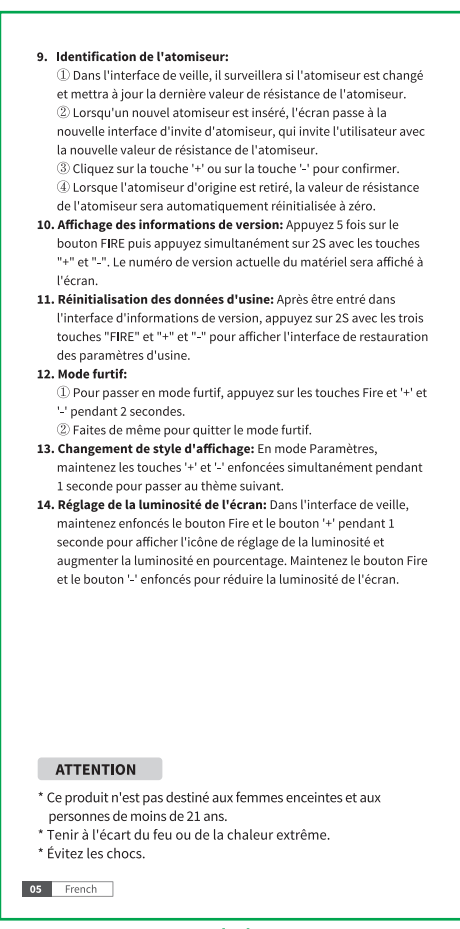

11

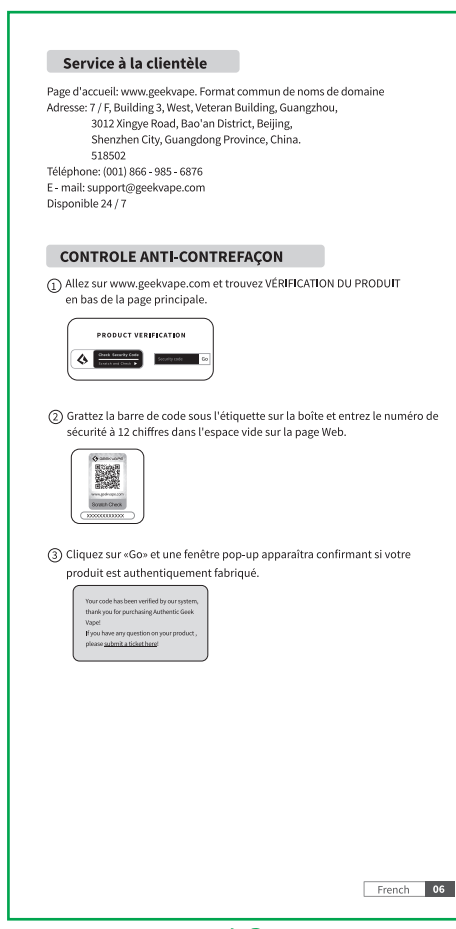

12

2

德语

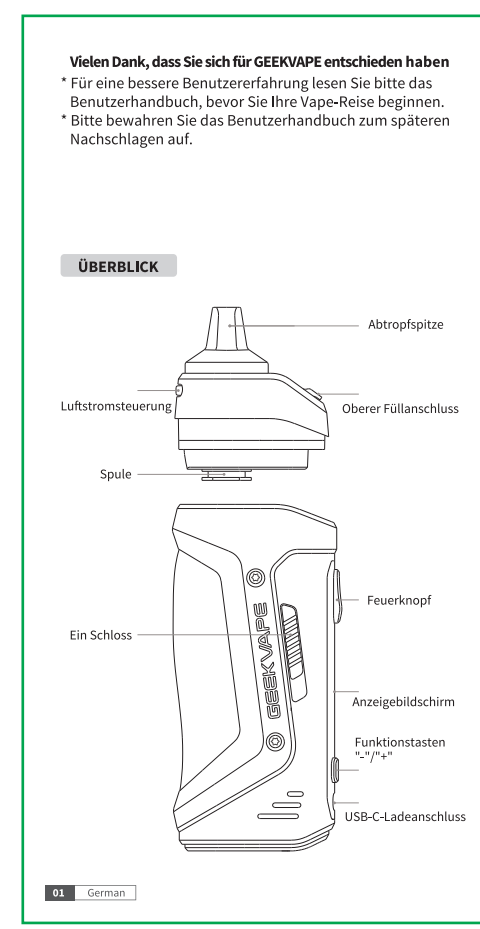

13

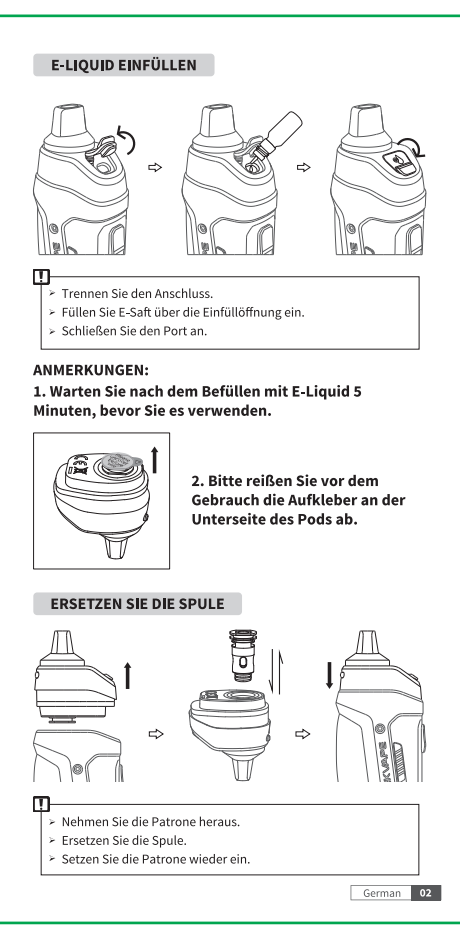

14

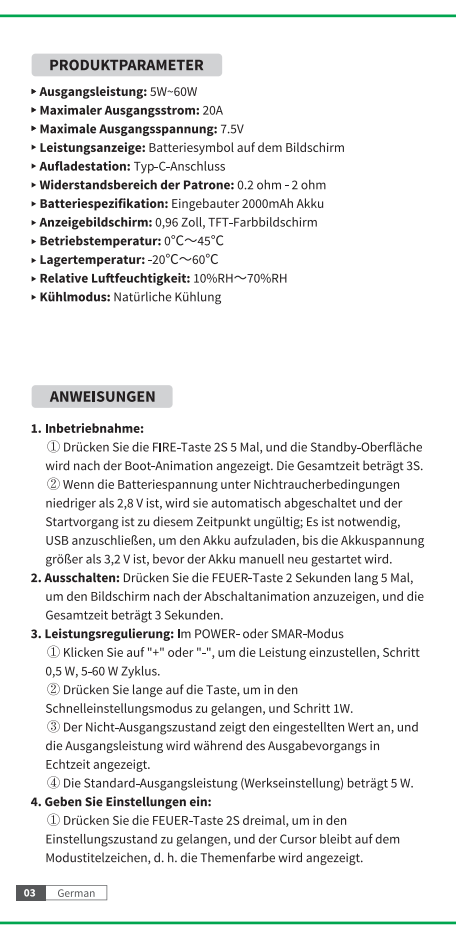

15

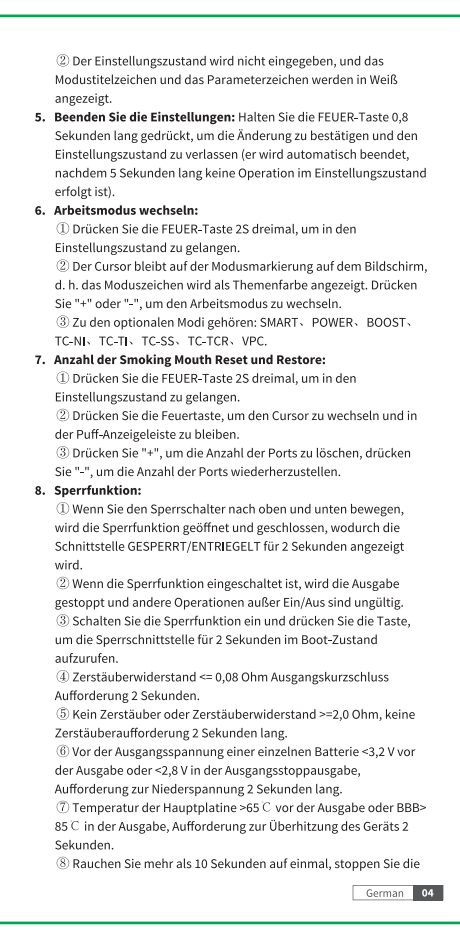

16

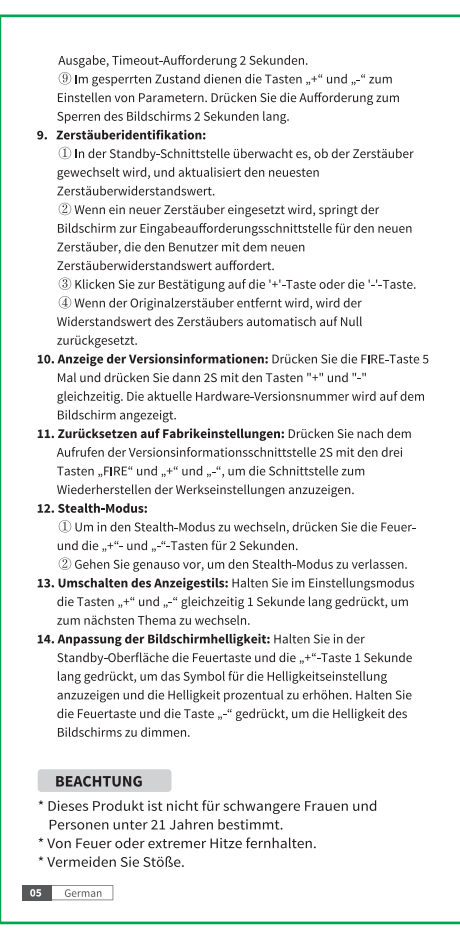

17

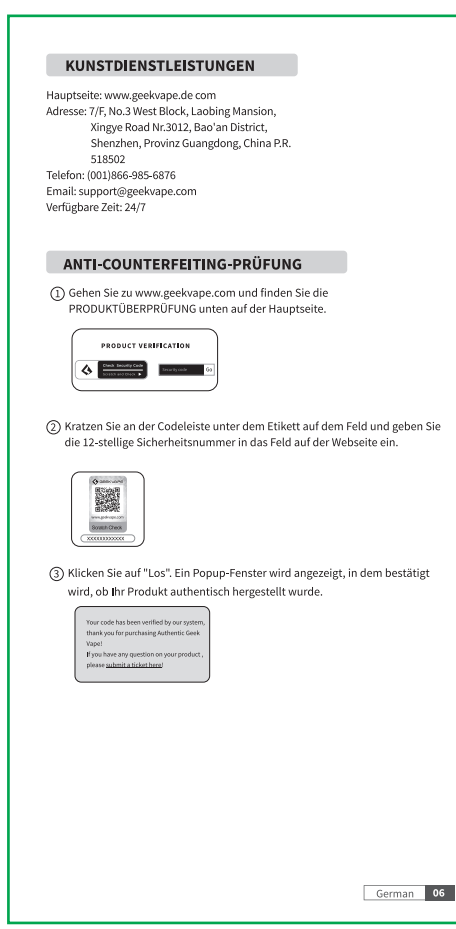

18

- 要求:
- 1.材料: 80g书写纸
 - 2.成品尺寸: 62*120mm≤0.5
 - 3.工艺: 双面印刷, 骑马订, 56P。
 - 4.颜色: 印单黑, 色差ΔE≤1.00
 - 5.油墨, 要符合欧盟为RoHS环保标准。
 - 6.页码顺序依次按封面、1、2...53、54、封底
印刷以文件为准, 严格按图纸做货。裁切边缘须整齐无毛边。

1

 深圳市基克纳科技有限公司 Geekvape Technology co, LTD		绘图 PRODUCTNAME	魏鹏	比例 SCALE	1:1
		未标公差 OTHER TOLERANEC	产品名称 PRODUCTNAME	Aegis Boost 2 Kit - 说明书	2022/2/21
	产品编码 PART NO	GS0216	审核 CHECKED	 	单位: mm A1
	产品图号 PART NO	GS0216-P-19	核准 APPROVED	 	